

915Mhz ISM band Antenna

Ref: PR0002700

Key Features

915 MHz ISM
- 902-928 MHz
Connector Mount
Ground Plane Independent
Hinged Connector
Dimensions 113 x 10 mm



1. Antenna and electrical specifications

Parameters	915 MHz ISM Antenna
Standards	ZigBee, ISM, SIGFOX, LoRa
Band (MHz)	915 MHz
Frequency (MHz)	902-928
Return Loss (dB)	~-13.9
VSWR	~1.5:1
Efficiency (%)	~25
Peak Gain (dBi)	~-2.5
Average Gain (dB)	~-6.0
Impedance (Ohm)	50
Polarisation	Linear
Radiation Pattern	Omni-Directional
Max. Input Power (W)	25
Connector Type	SMA-Male Standard

Antenna Measurement Conditions:

Free Space

Measured in Certified CTIA 3D Anechoic Chambe

r

2. Mechanical and environmental specifications

Specifications	
Mounting Type	Connector Mount
Dimensions (mm)	10 x 113
Radome	ABS UV Stable
Radome color	Black
Connector Feature	Hinged
Operating Temperature (C)	-40 to +85
Storage Temperature (C)	-40 to +85
Substance Compliance	RoHS

3. Antenna parameters

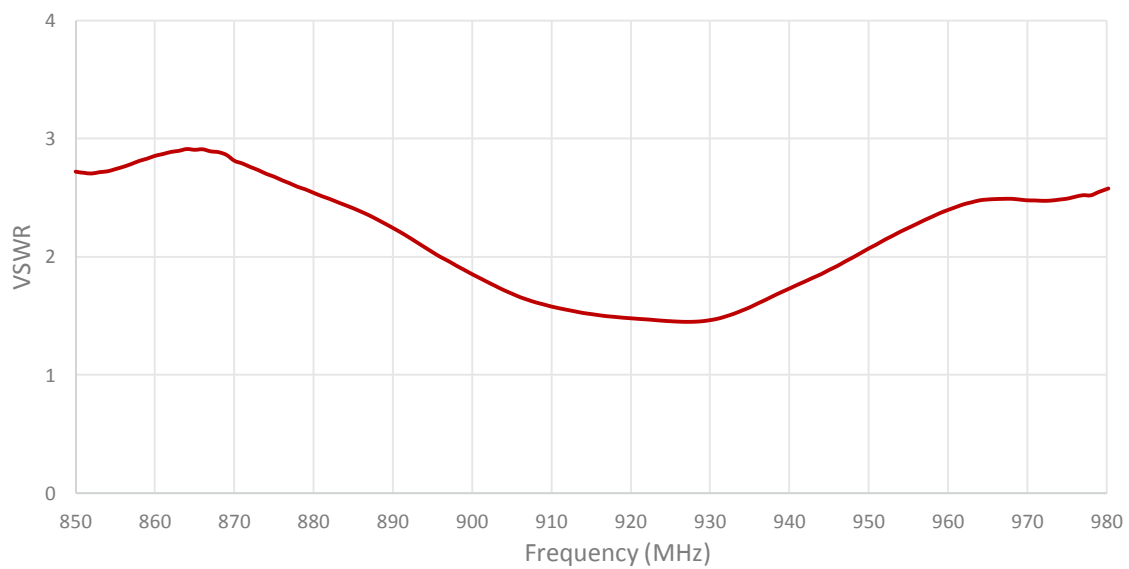
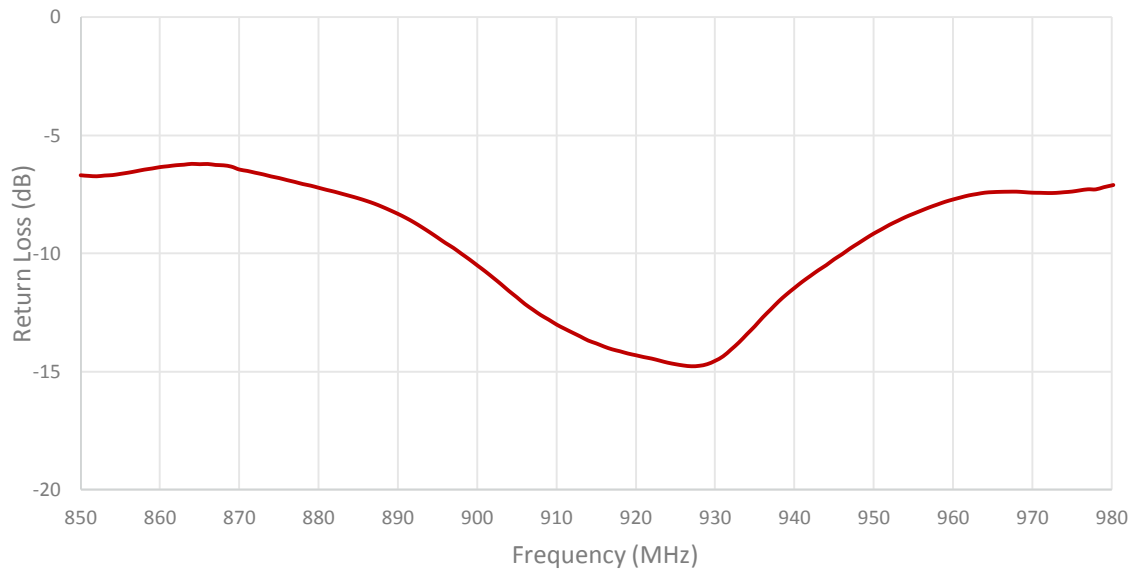

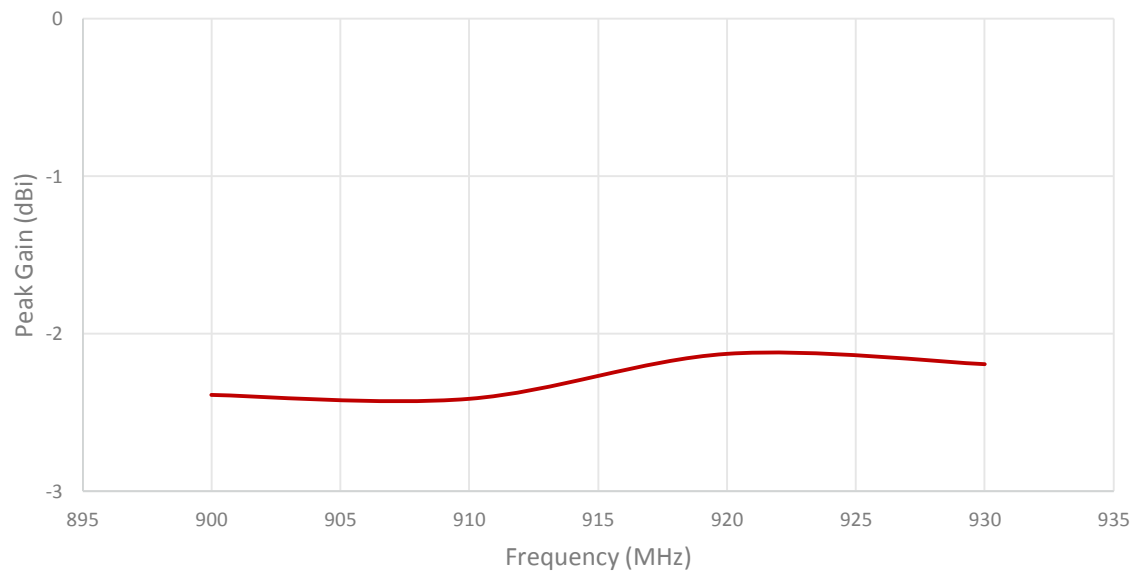
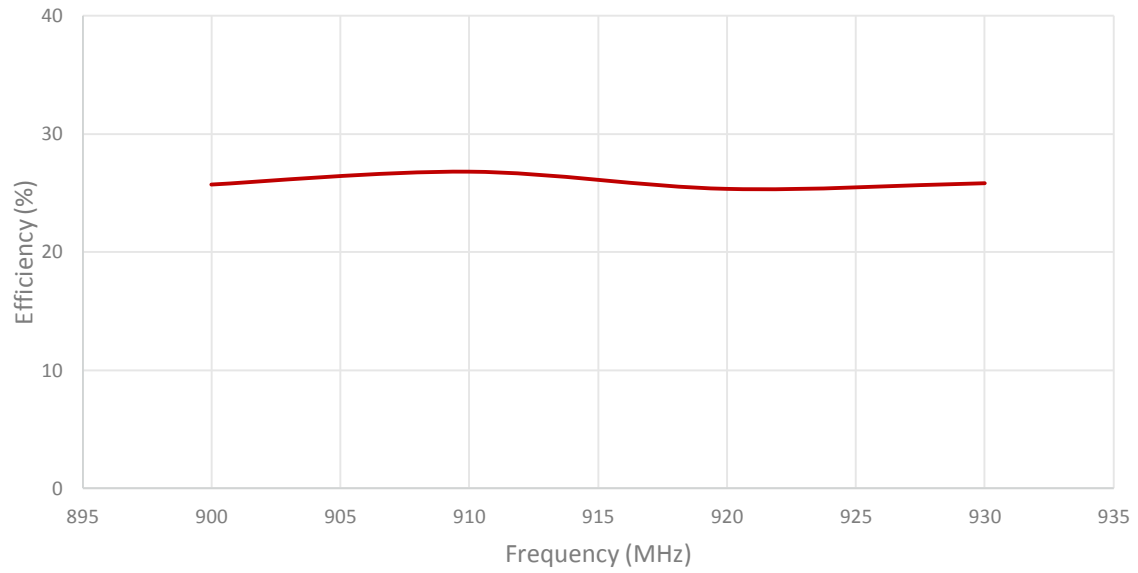

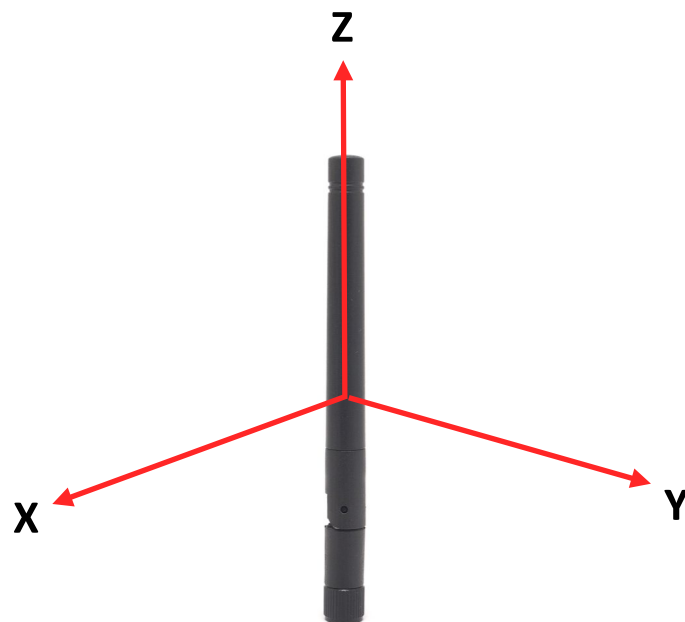
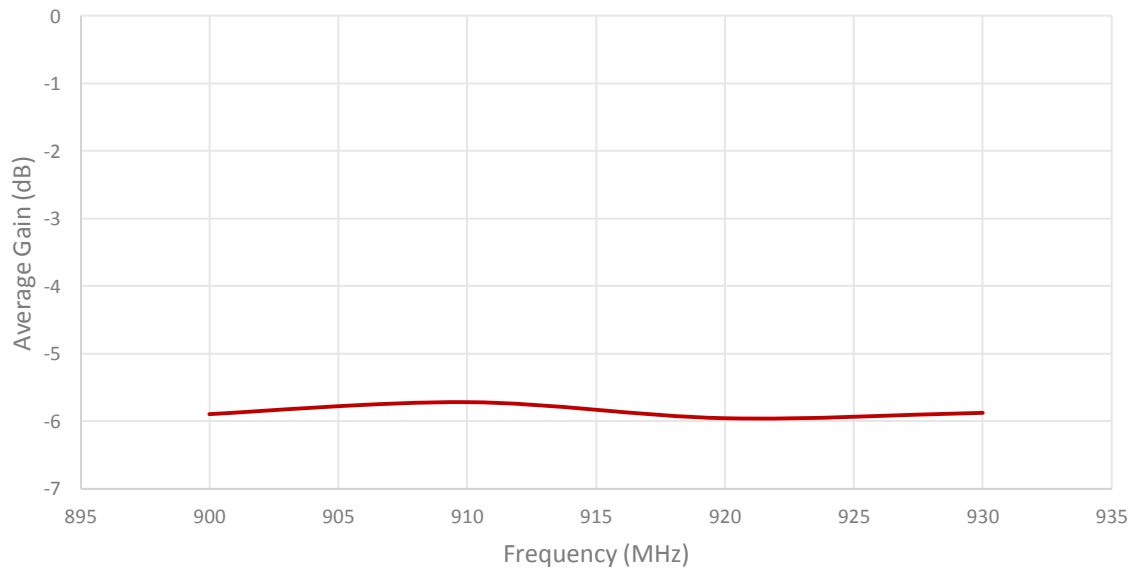

Radiation pattern reference

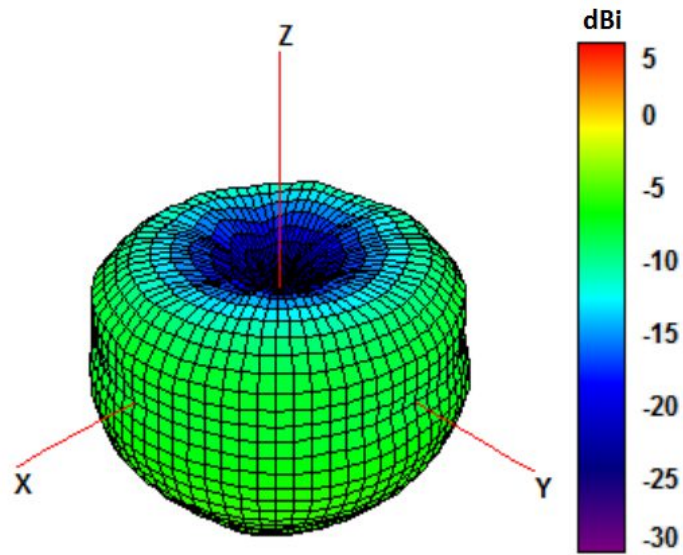

915 MHz Radiation pattern

4. Antenna drawings

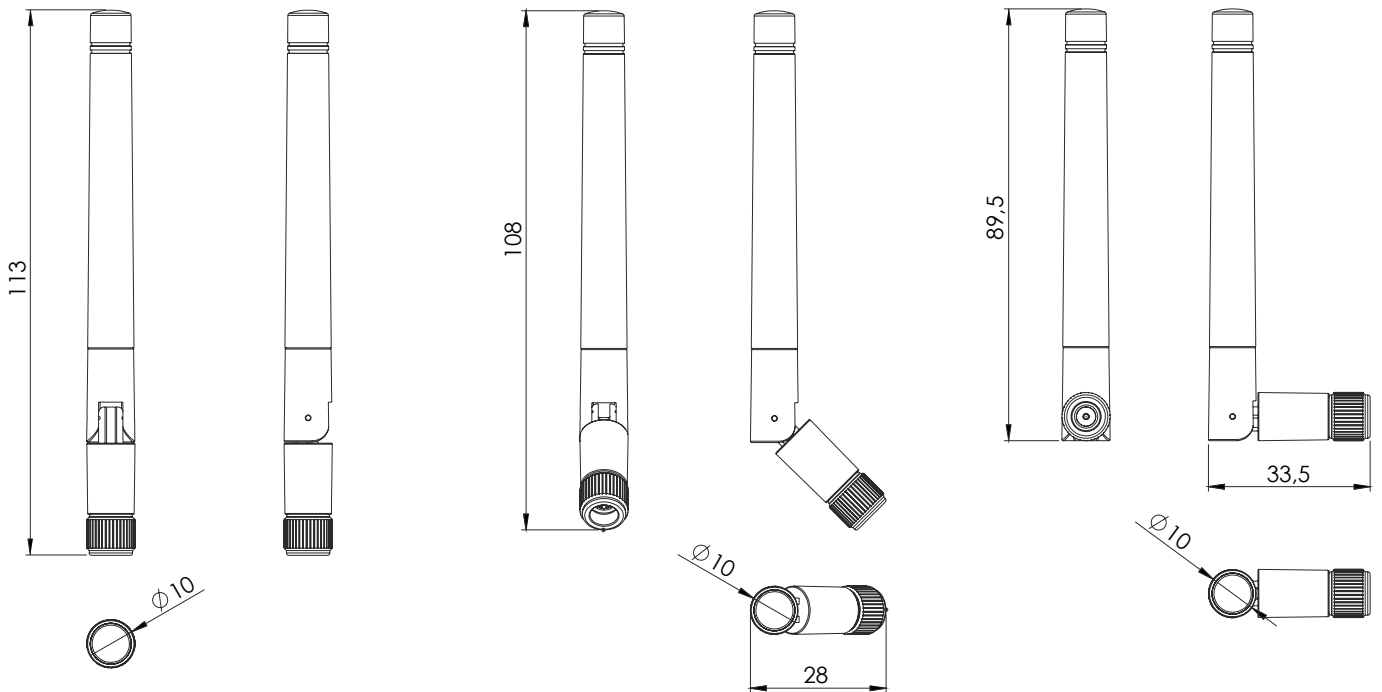

5. Antenna Images

