



Indoor Ambiance Monitoring Sensor

Featuring LoRaWAN®

AM300 Series

User Guide



Applicability

This guide is applicable to AM300 series sensors shown as follows, except where otherwise indicated.

Model	Description
AM307	Indoor Ambiance Sensor (Temp, Hum, Light, Motion, CO ₂ , TVOC, Pressure)
AM319	Indoor Ambiance Sensor (Temp, Hum, Light, Motion, CO ₂ , TVOC, Pressure, PM2.5, PM10, HCHO/O ₃)

Safety Precautions

Milesight will not shoulder responsibility for any loss or damage resulting from not following the instructions of this operating guide.

- ❖ The device must not be disassembled or remodeled in any way.
- ❖ In order to protect the security of the device, please change device password when first configuration. The default password is 123456.
- ❖ Do not place the device outdoors where the temperature is below/above operating range. Do not place the device close to objects with naked flames, heat source (oven or sunlight), cold source, liquid and extreme temperature changes.
- ❖ The device is not intended to be used as a reference sensor, and Milesight will not should responsibility for any damage which may result from inaccurate readings.
- ❖ The battery should be removed from the device if it is not to be used for an extended period. Otherwise, the battery might leak and damage the device. Never leave a discharged battery in the battery compartment.
- ❖ The device must never be subjected to shocks or impacts.
- ❖ Do not clean the device with detergents or solvents such as benzene or alcohol. To clean the device, wipe with a soft moistened cloth. Use another soft, dry cloth to wipe dry.

Declaration of Conformity

AM300 series is in conformity with the essential requirements and other relevant provisions of the CE, FCC, and RoHS.

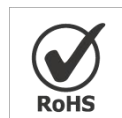

Copyright © 2011-2022 Milesight. All rights reserved.

All information in this guide is protected by copyright law. Whereby, no organization or individual shall copy or reproduce the whole or part of this user guide by any means without written authorization from Xiamen Milesight IoT Co., Ltd.

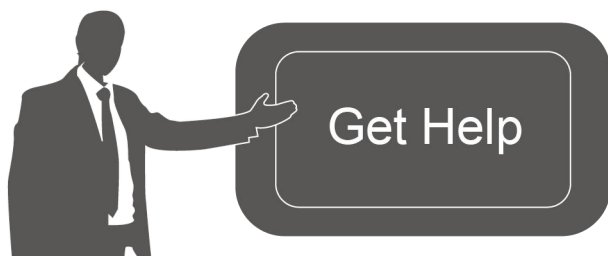

For assistance, please contact

Milesight technical support:

Email: iot.support@milesight.com

Tel: 86-592-5085280

Fax: 86-592-5023065

Address: Building C09, Software Park III,
Xiamen 361024, China

Revision History

Date	Doc Version	Description
Oct.9, 2021	V 1.0	Initial version

Contents

1. Product Introduction.....	5
1.1 Overview.....	5
1.2 Features.....	5
2. Hardware Introduction.....	5
2.1 Packing List.....	5
2.2 Hardware Overview.....	6
2.3 E-ink Screen.....	6
2.3.1 Screen Description.....	6
2.3.2 Screen Mode Switch.....	8
2.4 Button and Traffic Light.....	8
2.5 Dimensions.....	8
3. Power Supply.....	9
4. Operation Guide.....	9
4.1 Log in the ToolBox.....	9
4.1.1 NFC Configuration.....	9
4.1.2 USB Configuration.....	10
4.2 LoRaWAN Settings.....	11
4.3 Time Synchronization.....	14
4.4 Basic Settings.....	15
4.5 Advanced Settings.....	16
4.5.1 Data Collection Settings.....	16
4.5.2 Calibration Settings.....	17
4.5.3 Threshold Settings.....	18
4.5.4 Data Storage.....	19
4.6 Maintenance.....	20
4.6.1 Upgrade.....	20
4.6.2 Backup.....	21
4.6.3 Reset to Factory Default.....	22
5. Installation.....	23
6. Device Payload.....	25
6.1 Basic Information.....	25
6.2 Sensor Data.....	25
6.3 Downlink Commands.....	27
Appendix.....	28
Carbon Dioxide Levels and Guidelines.....	28
TVOC Levels and Guidelines.....	28

1. Product Introduction

1.1 Overview

AM300 series is a compact indoor ambience monitoring sensor including motion, humidity, temperature, light, TVOC, CO₂, HCHO/O₃ level, barometric pressure and PM2.5 & PM10 for wireless LoRa network. It is equipped with NFC (Near Field Communication) and can easily be configured via a smartphone or a PC software.

Sensor data are transmitted in real-time using standard LoRaWAN[®] protocol. LoRaWAN[®] enables encrypted radio transmissions over long distance while consuming very little power. The user can obtain sensor data and view the trend of data change through Milesight IoT Cloud or through the user's own Network Server.

1.2 Features

- Robust LoRa connectivity for indoor or HVAC environments
- Integrated multiple sensors like temperature, humidity, light, air quality, etc.
- Easy configuration via NFC
- Multiple display mode and clear emoticon on the e-ink screen
- Equipped with traffic light and buzzer to indicate threshold
- Standard LoRaWAN[®] supported
- Milesight IoT Cloud compliant
- Battery or DC power supply

2. Hardware Introduction

2.1 Packing List

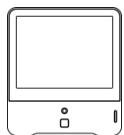

1 × AM300 Series
Device

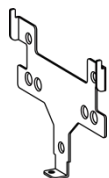

1 × Mounting
Bracket



1 × 3M
Double-Sided
Tape



3 × Wall
Mounting Kits



1 ×
Theft-Deterring
Screw

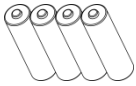

4 x

ER14505 Li-SOCl₂
Batteries
(AM307 Only)

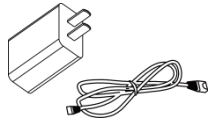

1 x

Type-C Cable (1.2 m)
& Power Adapter
(AM319 Only)



1 x

Quick Guide



1 x

Warranty Card

! If any of the above items is missing or damaged, please contact your sales Representative.



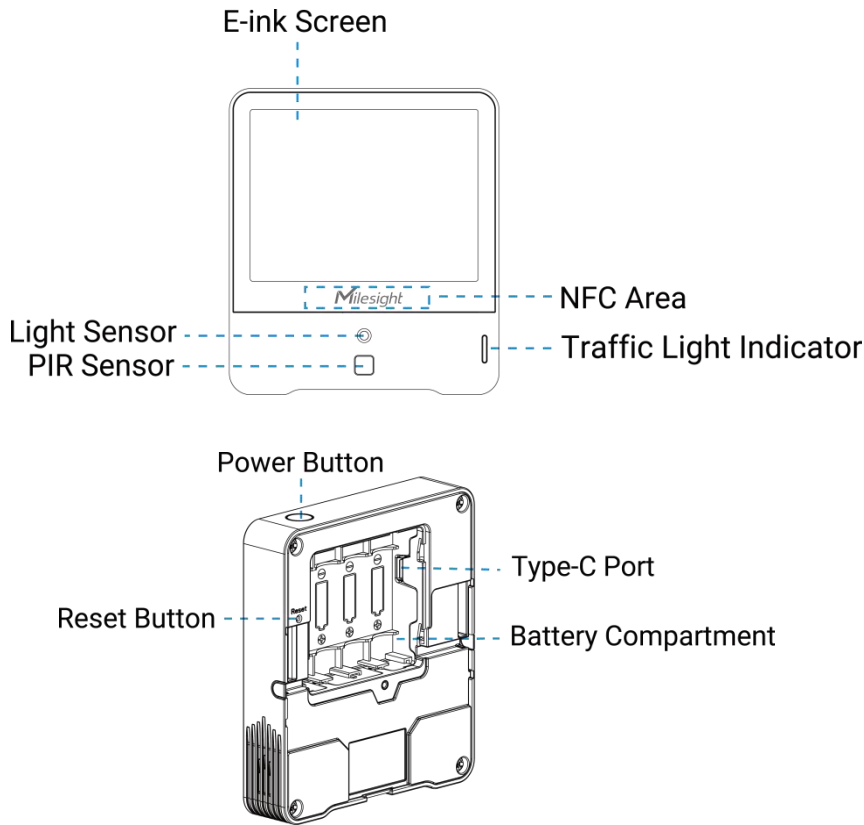









2.2 Hardware Overview

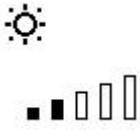

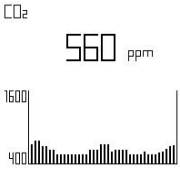
2.3 E-ink Screen

2.3.1 Screen Description

Icon	Description
	Battery level (AM307 Only)
	Battery is exhausted (AM307 Only).

01/01/2021 07:02	Sync time with software or mobile App.
	The device joins the network.
	The device fails to join the network.
	Temperature
	Humidity
	Level 0: 0-5 lux Level 1: 6-50 lux Level 2: 51-100 lux Level 3: 101-500 lux Level 4: 501-2000 lux Level 5: > 2000 lux
	Level 0: 0-50 Level 1: 51-100 Level 2: 101-150 Level 3: 151-200 Level 4: 201-250 Level 5: 251-500
	Show CO ₂ levels history tendency from 400 to 1600 ppm
	CO ₂ /TVOC/PM2.5/PM10/HCHO/O ₃ exceeds the Polluted threshold
	CO ₂ /TVOC/PM2.5/PM10/HCHO/O ₃ exceeds the Bad threshold
	Excellent Environment
	When one of the concentrations of air pollutants of CO ₂ , TVOC, PM2.5, PM10, HCHO/O ₃ exceeds the Polluted threshold
	When one of the concentrations of air pollutants of CO ₂ , TVOC, PM2.5, PM10, HCHO/O ₃ exceeds the Bad threshold

Note:

- AM300 series will update screen data every 1 minute and do a full-screen refresh every 30 minutes (AM319) or 60 minutes (AM307) in order to remove ghosting.
- When AM300 series detects the temperature beyond the range from 0°C to 40°C, the screen will close automatically.
- Please refer [section 4.5.3](#) for Excellent/Polluted/Bad threshold settings.

2.3.2 Screen Mode Switch

Here are 3 methods to switch between the three modes:

- Power button: Quick press the power button to switch the mode.
- Mobile App: Go to Milesight ToolBox App menu “Device > Setting > General Settings” to select screen display mode.
- Software: Go to Toolbox menu “Device Settings > Basic > Basic Settings” to select screen display mode.

2.4 Button and Traffic Light

Function	Action	Light Status
Power ON/OFF	Press and hold the power button for more than 3 seconds.	Power On: Off → On
		Power Off: On → Off
Switch Screen Display Mode	Quick press the power button once.	Blinks once
Reset to Factory Default	Press and hold the reset button for more than 10 seconds.	Quickly Blinks
Air Quality Level Indication	Indicate the 3 levels of air quality according to threshold setting. When one of the concentrations of air pollutants of CO ₂ , TVOC, PM2.5, PM10 or HCHO/O ₃ exceeds the threshold, the light color will change to orange or red	Excellent: Blinks/Always On (Configurable)
		Polluted: Blinks/Always On (Configurable)
		Bad: Blinks/Always On (Configurable)

Note:

- If the traffic light is disabled, it will not show air quality level indication.
- AM319 supports Traffic Light as Blinking or Always On to indicate Polluted or Bad indoor ambience, while AM307 only supports Blinking mode.

2.5 Dimensions(mm)

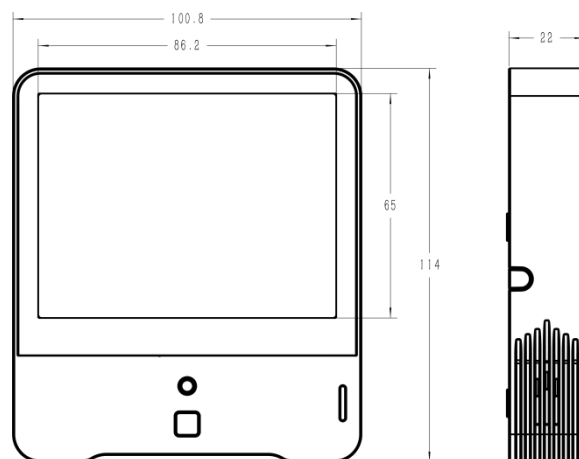

3. Power Supply

1. Release the screw at the back of device and remove the rear cover.
2. Install the batteries or type-C cable to the device. If the device is powered via type-C port, then left or right side should make an opening to pass through the type-C cable.

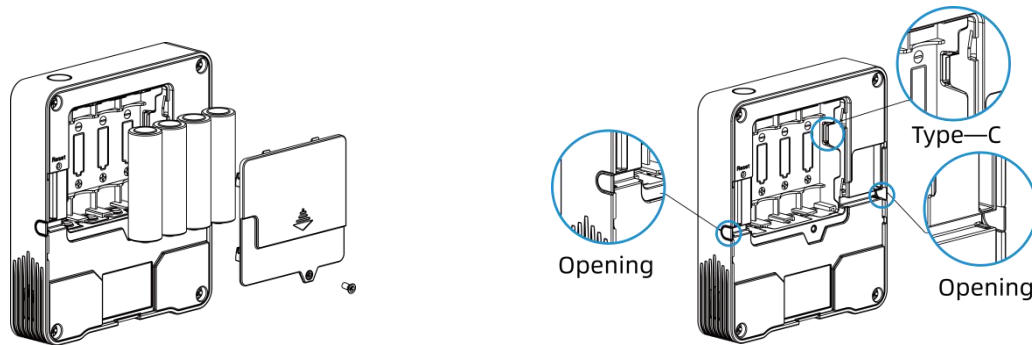

3. Fix the rear cover back to device with the fixing screw.

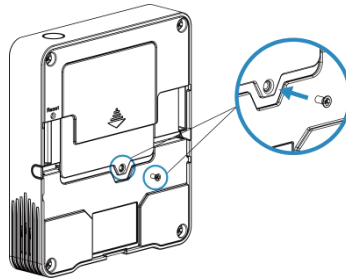

Note:

- AM307 can be powered via USB type-C port or by ER14505 Li-SOCl₂ batteries. When batteries and external power are both used, external power will be the preferred power supply option.
- AM319 supports powered via USB type-C port only.
- Type-C port can't be used to charge battery.

4. Operation Guide

4.1 Log in the ToolBox

AM300 series can be monitored and configured via ToolBox App or ToolBox software. Please select one of them to complete configuration.

4.1.1 NFC Configuration

1. Download and install "Milesight ToolBox" App from Google Play or Apple App Store.
2. Enable NFC on the smartphone and launch Milesight ToolBox.
3. Attach the smartphone with NFC area to the device to read device information. Basic

information and settings of the device will be shown on ToolBox App if it's recognized successfully. You can read and configure the device by tapping the Read/Write device on the App. In order to protect the security of the device, please change password when first configuration. The default password is **123456**.

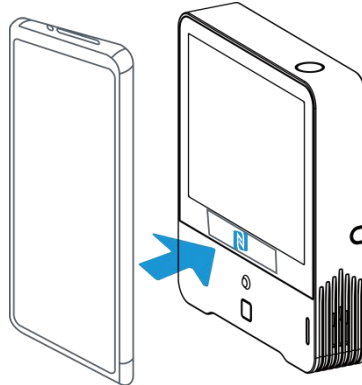

Note:

- 1) Ensure the location of smartphone NFC area and it's recommended to take off phone case.
- 2) If the smartphone fails to read/write configurations via NFC, keep the phone away and back to try again.
- 3) AM300 series can also be configured by dedicated NFC reader, which can be purchased from Milesight IoT.

4.1.2 USB Configuration

1. Download ToolBox software from www.milesight-iot.com.
2. Connect the device to a computer via Type-C port.

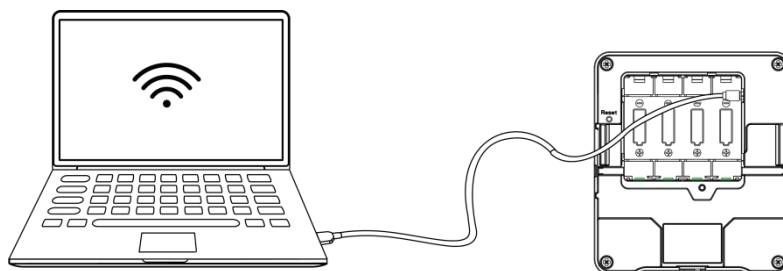

3. Open the ToolBox and select type as "General", then click password to log in ToolBox. (Default password: **123456**)

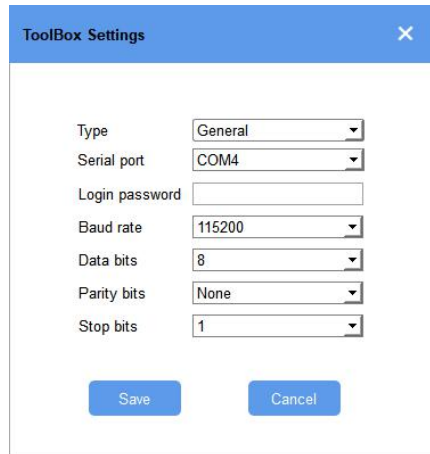

ToolBox Settings

Type: General

Serial port: COM4

Login password:

Baud rate: 115200

Data bits: 8

Parity bits: None

Stop bits: 1

Save Cancel

4. After logging in the ToolBox, you can click “Power On” or “Power Off” to turn on/off device and change other settings.

Status >

Power Off

Model:	AM319-470M
Serial Number:	6710B32112801913
PN:	HCHO
Device EUI:	24e124710b321128
Firmware Version:	01.01
Hardware Version:	1.0
Device Status:	On
Join Status:	Activate
RSSI/SNR:	-101/4
Temperature:	27.0°C
Humidity:	59.00%

4.2 LoRaWAN Settings

LoRaWAN settings is used for configuring the transmission parameters in LoRaWAN® network.

Step 1: Go to “LoRaWAN Settings -> Basic” of ToolBox software or “Device -> Settings -> LoRaWAN Settings” of ToolBox App to configure join type, App EUI, App Key and other information. You can also keep all settings by default.

Device EUI	<input type="text" value="24E124127A270222"/>
App EUI	<input type="text" value="24E124C0002A0001"/>
Application Port	<input type="text" value="85"/>
Join Type	<input type="text" value="OTAA"/>
LoRaWAN Version	<input type="text" value="V1.1.0"/>
Application Key	<input type="text" value="*****"/>
Spread Factor	<input type="text" value="SF10-DR2"/>
Confirmed Mode	<input type="checkbox"/>
Rejoin Mode	<input checked="" type="checkbox"/>
Set the number of packets sent	<input type="text" value="32"/> packets
ADR Mode	<input checked="" type="checkbox"/>

Parameters	Description
Device EUI	Unique ID of the device which can also be found on the label.
App EUI	Default App EUI is 24E124C0002A0001.
Application Port	The port is used for sending and receiving data, default port is 85.
Join Type	OTAA and ABP mode are available.
LoRaWAN Version	V1.0.2, V1.0.3, V1.1 are available.
Application Key	Appkey for OTAA mode, default is 5572404C696E6B4C6F52613230313823.
Device Address	DevAddr for ABP mode, default is the 5 th to 12 th digits of SN.
Network Session Key	Nwkskey for ABP mode, default is 5572404C696E6B4C6F52613230313823.
Application Session Key	Appskey for ABP mode, default is 5572404C696E6B4C6F52613230313823.
Spread Factor	If ADR is disabled, the device will send data via this spread factor.
Confirmed Mode	If the device does not receive ACK packet from network server, it will resend data 3 times at most.
Rejoin Mode	Reporting interval \leq 30 mins: the device will send specific amount of LoRaMAC packets to check connection status every 30 mins; If there is no reply after specific amount of packets sent, the device will re-join. Reporting interval $>$ 30 mins: the device will send specific amount of LoRaMAC packets to check connection status every reporting interval; If there is no reply after specific amount of packets sent, the device will re-join.

ADR Mode	Allow network server to adjust datarate of the device.
Tx Power	Transmit power of the device.

Note:

- 1) Please contact sales for device EUI list if there are many units.
- 2) Please contact sales if you need random App keys before purchase.
- 3) Select OTAA mode if you use Milesight IoT cloud to manage devices.
- 4) Only OTAA mode supports rejoin mode.

Step 2: Go to “LoRaWAN -> Channel” of ToolBox software or “Settings -> LoRaWAN Settings” of ToolBox App to select supported frequency and select channels to send uplinks. Make sure the channels match the LoRaWAN® gateway.

Support Frequency : EU868				
<input type="checkbox"/>	Index	Frequency/MHz	Max Datarate	Min Datarate
<input checked="" type="checkbox"/>	0	868.1	5-SF7BW125	0-SF12BW125
<input checked="" type="checkbox"/>	1	868.3	5-SF7BW125	0-SF12BW125
<input checked="" type="checkbox"/>	2	868.5	5-SF7BW125	0-SF12BW125
<input type="checkbox"/>	3	0	5-SF7BW125	0-SF12BW125
<input type="checkbox"/>	4	0	5-SF7BW125	0-SF12BW125
<input type="checkbox"/>	5	0	5-SF7BW125	0-SF12BW125
<input type="checkbox"/>	6	0	5-SF7BW125	0-SF12BW125
<input type="checkbox"/>	7	0	5-SF7BW125	0-SF12BW125

If frequency is one of CN470/AU915/US915, you can enter the index of the channel that you want to enable in the input box, making them separated by commas.

Examples:

- 1, 40: Enabling Channel 1 and Channel 40
- 1-40: Enabling Channel 1 to Channel 40
- 1-40, 60: Enabling Channel 1 to Channel 40 and Channel 60
- All: Enabling all channels
- Null: Indicates that all channels are disabled

Support Frequency : AU915

Enabled Channel Index: 0-71

Channel Index	Frequency/MHz	Channel Spacing/MHz	BW/kHz
0 - 15	915.2 - 918.2	0.2	125
16 - 31	918.4 - 921.4	0.2	125
32 - 47	921.6 - 924.6	0.2	125
48 - 63	924.8 - 927.8	0.2	125
64 - 71	915.9 - 927.1	1.6	500

Note:

For -868M model, the default frequency is EU868;

For -915M model, the default frequency is AU915.

4.3 Time Synchronization

Mobile App Configuration:

Go to "Device -> Status" to click "Sync" to sync the time on the screen.

Software Configuration:

Go to "Status" page to sync the time on the screen.

The screenshot shows the 'Status' page of the Milesight IoT mobile app. On the left, there is a list of device parameters with their current values and a 'Sync' button next to the 'Device Time' entry. On the right, a detailed view of the 'Status' page is shown, listing various sensor readings and a 'Sync' button at the bottom.

Parameter	Value	Action
Device Status	ON	Toggle
Join Status	Activated	None
RSSI/SNR	-44/9	None
Device Time	1970-01-24 09:10	Sync
Temperature	27.0 °C	None
Humidity	58.5 %	None
Activity Level (PIR)	1	None
Illumination	89 lux	None
Battery	61 %	None
Channel Mask	0003	None

Parameter	Value	Action
Device Status	On	None
Join Status	De-Activate	None
RSSI/SNR	0/0	None
Temperature	Disabled	None
Humidity	61.5%	None
Activity Level (PIR)	40	None
Illumination	85 lux	None
CO2	585 ppm	None
TVOC	210 ppb	None
Barometric Pressure	1006.1 hPa	None
Battery	92%	None
Channel Mask	000000000000000000000000f	None
Uplink Frame-counter	0	None
Downlink Frame-counter	0	None
Device Time	2020-08-21 13:18:12	Sync

4.4 Basic Settings

Go to “Device Settings -> Basic” of ToolBox software or “Device -> Settings -> General Settings” of ToolBox App to change the reporting interval, screen mode, etc.

Reporting Interval(min)	<input type="text" value="10"/>
Temperature Unit	<input type="text" value="°C"/>
LED Indicator	<input checked="" type="checkbox"/> <input type="text" value="Always On"/>
Buzzer	<input type="checkbox"/>
Check Button	<input type="checkbox"/>
Data Storage	<input type="checkbox"/>
Screen Display	<input checked="" type="checkbox"/>
Smart Screen Mode	<input checked="" type="checkbox"/>
Screen Display Mode	<input type="text" value="Mode2(Display CO2,PM2.5,PM10,"/>
Color Theme	<input type="text" value="White"/>
Change Password	<input type="checkbox"/>

Parameters	Description
Reporting Interval	Reporting interval of transmitting current sensor values to network server. Default: 10 mins, Range: 1-1080 mins
Temperature Unit	Change the temperature unit displayed on the ToolBox and screen. Note: 1) The temperature unit in the reporting package is fixed as °C. 2) Please modify the threshold settings if the unit is changed.
LED Indicator	Enable or disable the traffic light indicator to indicate air quality level. AM307: Blink AM319: Always On, Blink
Buzzer	Enable or disable the buzzer. If enabled, the buzzer will response when one of concentrations of air pollutants exceeds the Bad threshold. It will automatically stop when the concentration values are lower than the Bad threshold.
Check Button	When enabled, users can press the power button to stop the buzzer beep.

Data Storage	Disable or enable data storage locally. (see section 4.5.4 to export data)
Screen Display	Disable or enable screen display.
Screen Smart Mode	When PIR value is 0 (Vacant) and last for 20 mins, the screen will stop updating to save power.
Screen Display Mode	Select the screen display contents. AM307 Mode 1: Time&Date, CO ₂ , Temperature, Humidity Mode 2: CO ₂ , Temperature, Humidity, TVOC, light Mode 3: Time&Date, CO ₂ , Temperature, Humidity, TVOC, light AM319 Mode 1: Time&Date, CO ₂ , PM2.5&PM10, Temperature, Humidity Mode 2: CO ₂ , PM2.5&PM10, HCHO/O ₃ , Temperature, Humidity, TVOC, light Mode 3: Time&Date, CO ₂ , PM2.5&PM10, HCHO/O ₃ , Temperature, Humidity, TVOC, light
Color Theme	Select screen display background color as White or Black.
Change Password	Change the password for ToolBox App or software to read/write this device.

4.5 Advanced Settings

4.5.1 Data Collection Settings

Go to “**Device Settings->Basic**” of ToolBox software or “**Device -> Settings -> Data Collection Settings**” of ToolBox App to select the data you need to monitor. Among them, temperature, humidity and CO₂ are not allowed to disable. If any item is disabled, it will disappear from the screen.

Temperature	<input checked="" type="checkbox"/>
Humidity	<input checked="" type="checkbox"/>
CO2	<input checked="" type="checkbox"/>
Activity Level (PIR)	<input checked="" type="checkbox"/>
Illumination	<input type="checkbox"/>
TVOC	<input type="checkbox"/>
Barometric Pressure	<input checked="" type="checkbox"/>
PM2.5	<input checked="" type="checkbox"/>
PM10	<input checked="" type="checkbox"/>
HCHO	<input checked="" type="checkbox"/>

4.5.2 Calibration Settings

ToolBox supports numerical calibration for all items. Go to **“Device Settings -> Basic”** of ToolBox software or **“Device -> Settings -> Calibration Settings”** of ToolBox App to type the calibration value and save, the device will add the calibration value to raw value.

Temperature Calibration	<input checked="" type="checkbox"/>
Current Value	24.6 °C
Calibration Value	<input type="text" value="0"/> °C
Final Value	24.6 °C
Humidity Calibration	<input type="checkbox"/>
CO2 Calibration	<input type="checkbox"/>
Barometric Pressure Calibration	<input type="checkbox"/>
PM2.5 Calibration	<input type="checkbox"/>
PM10 Calibration	<input type="checkbox"/>
HCHO Calibration	<input type="checkbox"/>

Besides numerical calibration, ToolBox provides more calibration methods for CO₂:

Manual Calibration: Put the device in an open outdoor environment for more than 10 minutes and click this button to calibrate the CO₂ value.

Factory Calibration Restored: Clean the manual calibration and turn back to factory calibration.

Auto Background Calibration: When enabled, keep the device work in a well-ventilated environment for 7 days, then disable the calibration.

CO2 Calibration	<input checked="" type="checkbox"/>
	<input type="button" value="Manual Calibration"/> ?
	<input type="button" value="Restore Factory Calibration"/> ?
Auto Background Calibration	<input type="checkbox"/> ?
Current Value	1145 ppm
Calibration Value	<input type="text" value="0"/> ppm
Final Value	1145 ppm

4.5.3 Threshold Settings

Go to “Device Settings -> Basic” of ToolBox software or “Device -> Settings -> Threshold Settings” of ToolBox App to enable the threshold settings and input the threshold.

For temperature, it will upload the current data once instantly when temperature is over or below the threshold. Note that when you change the temperature unit, please re-configure the threshold.

Temperature / °C	<input checked="" type="checkbox"/>
Over	<input type="text" value="35"/>
Below	<input type="text" value="10"/>

For CO₂, TVOC, PM2.5, PM10 and HCHO/O₃, it supports defining Excellent, Polluted and Bad threshold for traffic light, buzzer and screen alarms. Besides, when one of concentrations of air pollutants exceeds the Bad threshold, AM300 series will upload the current data once instantly.

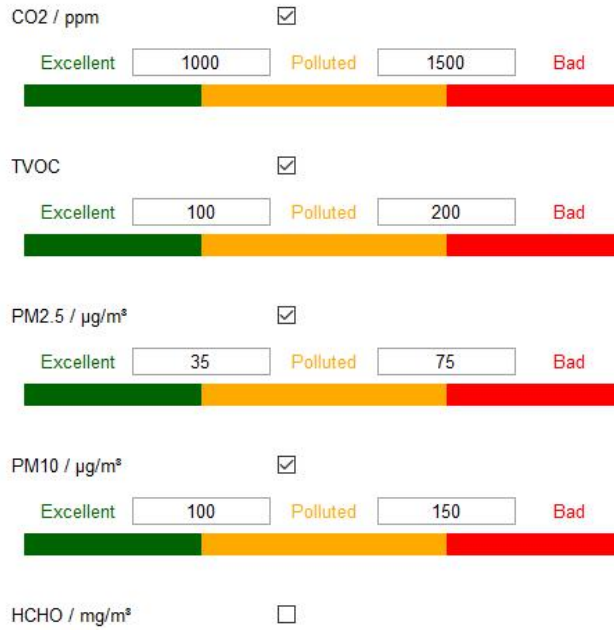

4.5.4 Data Storage

AM300 series supports storing more than 18000 data records locally and exports data via ToolBox App or ToolBox software. The device will record the data according to reporting interval.

1. Go to **“Device Settings -> Basic”** of ToolBox software or **“Device -> Settings -> General Settings”** of ToolBox App to enable data storage feature.
2. Go to **“Maintenance -> Basic”** of ToolBox software or **“Device -> Maintenance”** of ToolBox App, click **Export**, then select the data time range and click **Save** to export data.

Note: ToolBox App can only export last 7 days’ data. If you need to export more data, please use ToolBox software.

Maintenance >

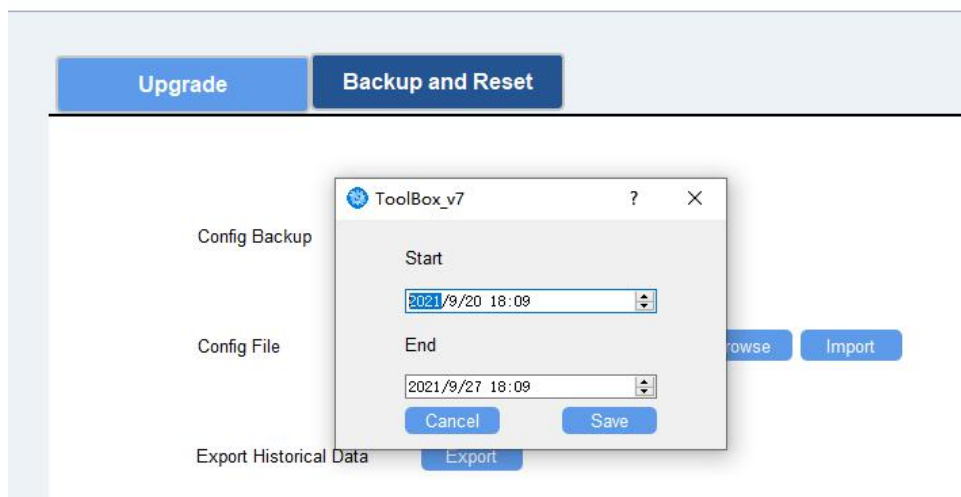

4.6 Maintenance

4.6.1 Upgrade

ToolBox Software:

1. Download firmware from www.milesight-iot.com to your PC.
2. Go to “Maintenance -> Upgrade” of ToolBox software, click “Browse” to import firmware and upgrade the device. You can also click “Up to Date” to search for the latest firmware of the device and upgrade.

Maintenance >

Upgrade		Backup and Reset	
Model:	AM319-470M		
Firmware Version:	01.01		
Hardware Version:	1.0		
Domain:	Beijing Server		
FOTA:	Up to date		
Update Locally	<input type="text"/>	Browse	Upgrade

ToolBox App:

1. Download firmware from www.milesight-iot.com to your smartphone.
2. Open ToolBox App and click “Browse” to import firmware and upgrade the device.

Note:

- 1) Operation on ToolBox is not supported during the upgrade.
- 2) Only Android version ToolBox supports the upgrade feature.

SN	6710B32112801913
Model	AM319-470M
Firmware Version	V1.1
Hardware Version	V1.0
Manual Upgrade	
Browse	

4.6.2 Backup

AM300 series supports configuration backup for easy and quick device configuration in bulk.

Backup is allowed only for devices with the same model and LoRaWAN® frequency band.

ToolBox Software:

1. Go to “**Maintenance -> Backup and Reset**” of ToolBox software, click “**Export**” to backup the device configuration.
2. Click “**Browse**” to import the backup file, then click “**Import**” to load the configuration.

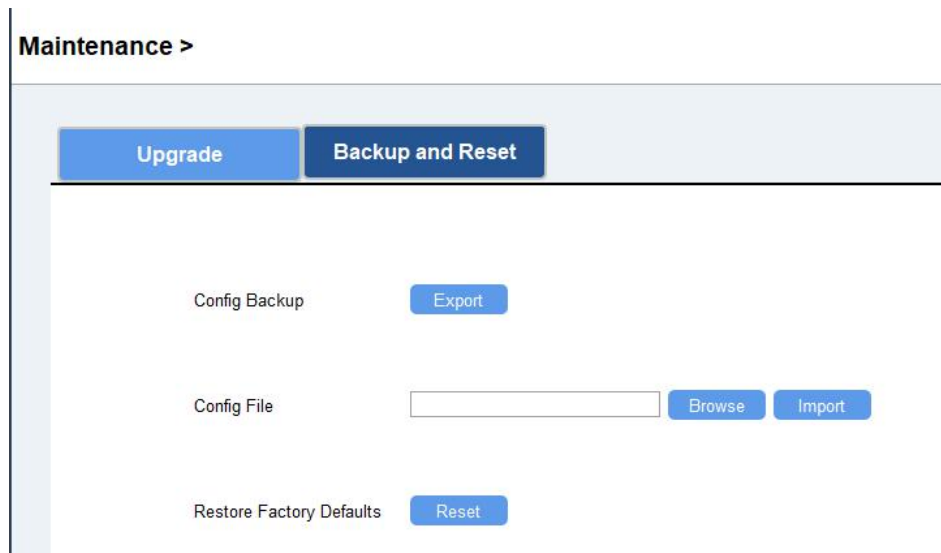

ToolBox App:

1. Go to “Template” page on the App and save current settings as a template. You can also edit the template file.
2. Select one template file that saved in the smartphone and click “Write”, then attach it to another device to write configuration.

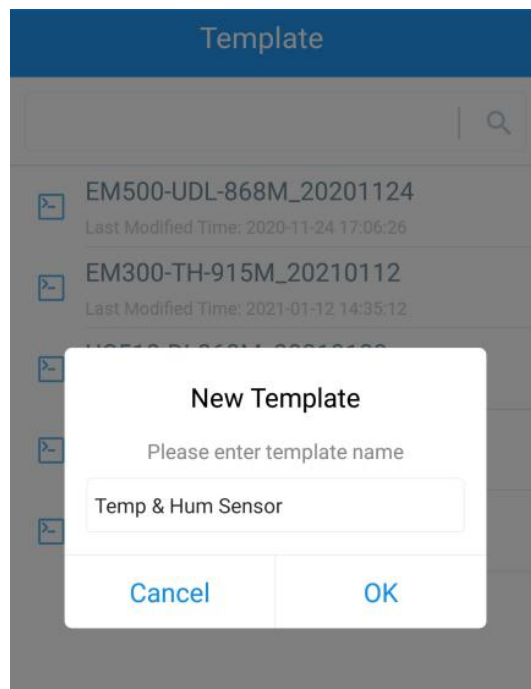

Note: Slide the template item to the left to edit or delete it. Click the template to edit the configurations.

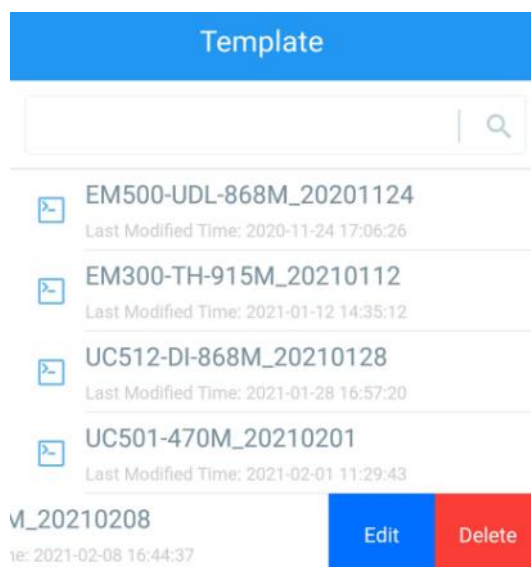

4.6.3 Reset to Factory Default

Please select one of following methods to reset device:

Via Hardware: Hold on reset button more than 10s.

Via Toolbox Software: Go to "Maintenance -> Backup and Reset" to click "Reset".

Via Toolbox App: Go to "Device -> Reset" to click "Reset", then attach smart phone with NFC area to device to complete reset.

5. Installation

Fixed by 3M Tape:

1. Paste 3M tape to the back of the mounting bracket, then tear the other side and place it on a flat surface.

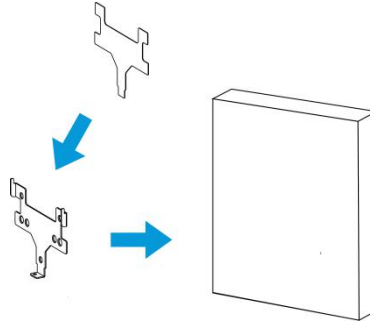

2. Put the device on the mounting bracket, then fix the bottom of the device to the bracket with the theft-detering screw.

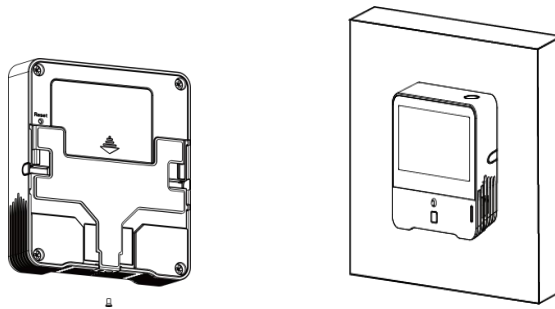

Wall Mounting:

1. Fix the wall plugs into the wall, then fix the mounting bracket to the wall plugs with screws.

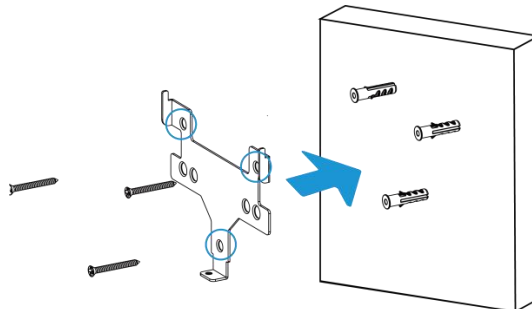

2. Put the device on the mounting bracket, then fix the bottom of the device to the bracket with a fixing screw.

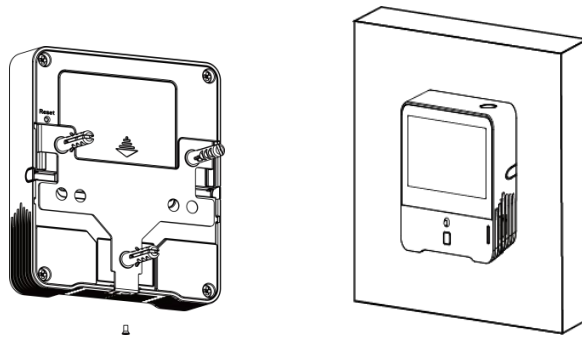

86Box Mounting:

1. Fix the mounting bracket to the 86box with screws. There are two kinds of screw modes to fix.
2. Put the device on the mounting bracket, then fix the bottom of the device to the bracket with a fixing screw.

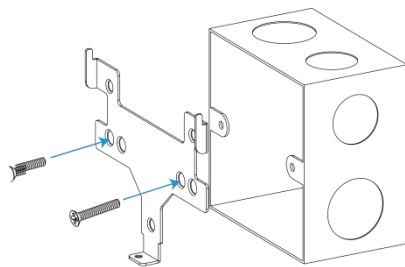

Screw Mode 1

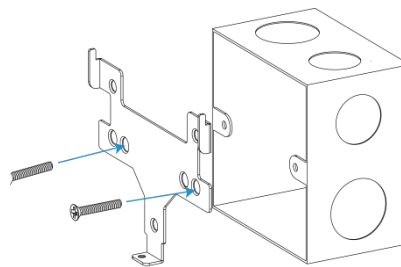

Screw Mode 2

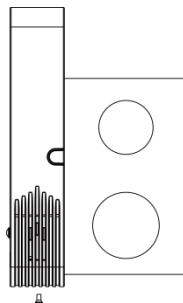

Note:

In order to ensure the best detection and LoRaWAN® communication effect, it is recommended to install AM300 series as follows:

- There should not be any isolates or barriers in PIR and light detection range.
- Do not mount the device where the temperature is below/above operating range and temperature varies greatly.
- Stay far away from any heat source or cold source like oven, refrigerator.
- Do not mount the device close to where airflow varies greatly like windows, vent, fan and air conditioner.
- Do not mount the device upside down.
- Do not place the device right to the window or door. If you have to, you'd better pull the curtain.
- It is recommended to install at least 1.5m high from floor.

6. Device Payload

All data are based on following format(HEX):

Channel1	Type1	Data1	Channel2	Type2	Data2	Channel 3	...
1 Byte	1 Byte	N Bytes	1 Byte	1 Byte	M Bytes	1 Byte	...

For decoder examples please find files on <https://github.com/Milesight-IoT/SensorDecoders>.

6.1 Basic Information

AM300 series sensors report basic information of sensor whenever joining the network.

Channel	Type	Description
ff	01(Protocol Version)	01=>V1
	09 (Hardware Version)	01 40 => V1.4
	0a (Software Version)	01 14 => V1.14
	0b (Power On)	Device is on
	0f (Device Type)	00: Class A, 01: Class B, 02: Class C
	16 (Device SN)	16 digits
	2e (LED Mode)	00: Off, 01: Always On, 02: Blink
	3e (Buzzer)	00: Off, 01: On

Example:

ff166710b32620711912 ff090100 ff0a0101 ff0f02					
Channel	Type	Value	Channel	Type	Value
ff	16 (Device SN)	6710b32620711912	ff	09 (Hardware version)	0100 (V1.0)
Channel	Type	Value	Channel	Type	Value
ff	0a (Software version)	0101 (V1.1)	ff	0f (Device Type)	02 (Class C)

6.2 Sensor Data

AM300 series sensors report sensor data according to reporting interval (10mins by default).

Item	Channel	Type	Description
Battery Level	01	75	UINT8, Unit: %, AM307 Only
Temperature	03	67	INT16, Unit: °C, Resolution: 0.1 °C
Humidity	04	68	UINT8, Unit: %, Resolution: 0.5 %

PIR Status	05	00	01: PIR is triggered 00: PIR is not triggered
Light Level	06	cb	00: 0-5 lux 01: 6-50 lux 02: 51-100 lux 03: 101-500 lux 04: 501-2000 lux 05: > 2000 lux
CO ₂	07	7d	UINT16, Unit: ppm
TVOC	08	7d	UINT16
Barometric Pressure	09	73	UINT16, Unit: hPa, Resolution: 0.1 hPa
HCHO	0a	7d	UINT16, Unit: mg/m ³ , Resolution: 0.01 mg/m ³
PM 2.5	0b	7d	UINT16, Unit: µg/m ³
PM 10	0c	7d	UINT16, Unit: µg/m ³
O ₃	0d	7d	UINT16, Unit: ppm
Buzzer Status	0e	01	00: buzzer is not beeping 01: buzzer is beeping Note: this only upload when one of the concentrations of air pollutants of CO ₂ , TVOC, PM2.5, PM10, HCHO/O ₃ exceeds the Bad threshold

Example:

1. Periodic Package

0367ea00 04688a 050001 06cb01 077dcd04 087d2000 09735127 0a7d0700 0b7d3b00 0c7d4300					
Channel	Type	Value	Channel	Type	Value
03	67 (Temperature)	ea 00 => 00 ea = 234 Temp=234*0.1=2 3.4°C	04	68 (Humidity)	8a=>138 Hum=138*0. 5=69%
Channel	Type	Value	Channel	Type	Value
05	00	01: PIR is triggered	06	cb (Light Level)	01= level 1 (6-50 lux)
Channel	Type	Value	Channel	Type	Value

07	7d	cd 04 => 04 cd =1229 ppm (CO ₂)	08	7d	20 00 => 00 20 =32 (TVOC IAQ index)
Channel	Type	Value	Channel	Type	Value
09	73 (Barometric Pressure)	51 27=>27 51=10044 Pressure=10065* 0.1=1006.5 hPa	0a	7d	07 00=>00 07=7 * 0.01 =0.07 mg/m ³ (HCHO)
Channel	Type	Value	Channel	Type	Value
0b	7d	3b 00=>00 3b=59 µg/m ³ (PM 2.5)	0c	7d	43 00=>00 43=67 µg/m ³ (PM 10)

- CO₂ value exceeds the Bad threshold.

077d0a060e0100					
Channel	Type	Value	Channel	Type	Value
07	7d	0a 06 => 06 0a =1546 ppm	0e	01	00=>Buzzer is not beeping

6.3 Downlink Commands

AM300 series sensors support downlink commands to configure the device. The application port is 85 by default.

Channel	Type	Description
ff	03(Set Reporting Interval)	2 Bytes, unit: s
	2c (Enquire LED and Buzzer Mode)	00(Reversed)
	3d (Stop the Buzzer)	00 (Reversed)

Example:

- Set reporting interval as 20 minutes.

ff03b004		
Channel	Type	Value
ff	03 (Set Reporting Interval)	b0 04=>04 b0=1200s =20 minutes

- Enquire traffic light and buzzer mode.

ff2c00		
Channel	Type	Value
ff	2c (Enquire LED and Buzzer mode)	00(Reversed)

Reply:

ff2e02 ff3e00					
Channel	Type	Value	Channel	Type	Value
ff	2e(LED Mode)	02=Blink	ff	3e (Buzzer Mode)	00=Off

Appendix

Carbon Dioxide Levels and Guidelines

CO ₂ Level	Description
400ppm	Normal outdoor air level.
400-1000ppm	Typical level indoors with good ventilation.
1000-2000ppm	Poor air quality - requires ventilation.
≥2000ppm	Headaches, sleepiness and stagnant, stale, stuffy air. Poor concentration, loss of attention, increased heart rate and slight nausea may also be present.
5000ppm	Workplace exposure limit (as 8-hour TWA) in most jurisdictions.
>40000ppm	Exposure may lead to serious oxygen deprivation resulting in permanent brain damage, coma, even death.

TVOC Levels and Guidelines

IAQ Index	Description
0-50	Excellent air quality.
51-100	Good air quality - No irritation or impact.
101-150	Light polluted. Need to ventilation.
151-200	Moderately polluted and there is possible more significant irritation. Need to increase ventilation with clean air.
201-250	Heavily polluted and exposition might lead to effects like headache depending on types of VOC. Need to optimize ventilation.
251-350	Severely polluted and cause severe health issue possible if harmful VOC presents. Need to maximize ventilation and reduce attendance.
>350	Extremely polluted and may cause headaches, additional

	neurotoxic effects. Need to maximize ventilation and avoid attendance.
--	--

-END-