



LoRaWAN[®] Controller

UC50x Series

User Guide



Safety Precautions

Milesight will not shoulder responsibility for any loss or damage resulting from not following the instructions of this operating guide.

- ❖ The device must not be remodeled in any way.
- ❖ Do not place the device close to objects with naked flames.
- ❖ Do not place the device where the temperature is below/above the operating range.
- ❖ Make sure electronic components do not drop out of the enclosure while opening.
- ❖ When installing the battery, please install it accurately, and do not install the reverse or wrong model.
- ❖ Make sure both batteries are newest when install, or battery life will be reduced.
- ❖ The device must never be subjected to shocks or impacts.

Declaration of Conformity

UC50x series is in conformity with the essential requirements and other relevant provisions of the CE, FCC, and RoHS.



Copyright © 2011-2022 Milesight. All rights reserved.

All information in this guide is protected by copyright law. Whereby, no organization or individual shall copy or reproduce the whole or part of this user guide by any means without written authorization from Xiamen Milesight IoT Co., Ltd.

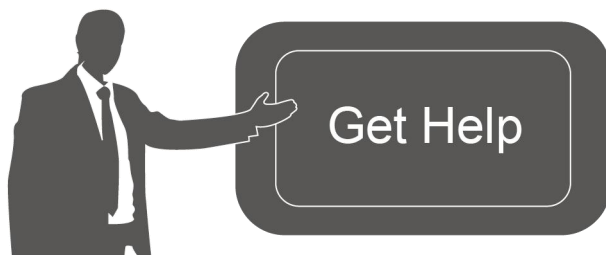

For assistance, please contact

Milesight technical support:

Email: iot.support@milesight.com

Support Portal: support.milesight-iot.com

Tel: 86-592-5085280

Fax: 86-592-5023065

Address: Building C09, Software Park III,
Xiamen 361024, China

Revision History

Date	Doc Version	Description
Dec. 9, 2021	V 2.0	Initial version based on hardware 2.0
June 16, 2022	V 2.1	Update 3.3V power output feature
Nov. 21, 2022	V 2.2	<ol style="list-style-type: none">1. Add RS485 byte order feature2. Add GPIO initial counting value modification feature

Contents

1. Product Introduction	5
1.1 Overview	5
1.2 Features	5
2. Hardware Introduction	5
2.1 Packing List	5
2.2 Hardware Overview	6
2.3 Internal Interfaces	7
2.4 Dimensions	8
3. Hardware Switch	8
4. Operation Guide	8
4.1 Log in the ToolBox	8
4.1.1 NFC Configuration	9
4.1.2 USB Configuration	9
4.2 LoRaWAN Settings	10
4.3 Interface Settings	13
4.3.1 RS485 Settings	14
4.3.2 RS232 Settings	17
4.3.3 GPIO Settings	18
4.3.4 AI Settings	20
4.4 Maintenance	22
4.4.1 Upgrade	22
4.4.2 Backup	23
4.4.3 Reset to Factory Default	24
5. Installation	25
6. Milesight IoT Cloud Management	26
7. Device Payload	27

1. Product Introduction

1.1 Overview

UC50x series is a LoRaWAN® controller used for data acquisition from multiple sensors. It contains different I/O interfaces such as analog inputs, digital inputs, digital outputs, serial ports and so on, which simplify the deployment and replacement of LoRaWAN® networks.

UC50x series can be easily and quickly configured by NFC or wired USB port. For outdoor applications, it provides solar or built-in battery power supply and is equipped with IP67-rated enclosure and M12 connectors to protect itself from water and dust in harsh environments.

1.2 Features

- Easy to connect with multiple wired sensors through GPIO/AI/RS232/RS485 interfaces
- Long transmission distance up to 15 km with line of sight
- Waterproof design including IP67 case and M12 connectors
- Solar powered and built-in battery optional
- Quick wireless configuration via NFC
- Compliant with standard LoRaWAN® gateways and network servers
- Quick and easy management with Milesight IoT Cloud solution

2. Hardware Introduction

2.1 Packing List



1 × UC50x
Device



2 × Data Cables
(30 cm)

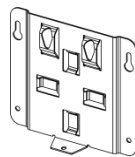

1 × Mounting
Bracket



4 × Wall
Mounting Kits



2 × Hose Clamps



1 × Fixing Screw



1 × Quick Guide



1 × Warranty Card

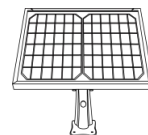

1 × Solar Panel Kit
(Optional)



If any of the above items is missing or damaged, please contact your sales Representative.

2.2 Hardware Overview

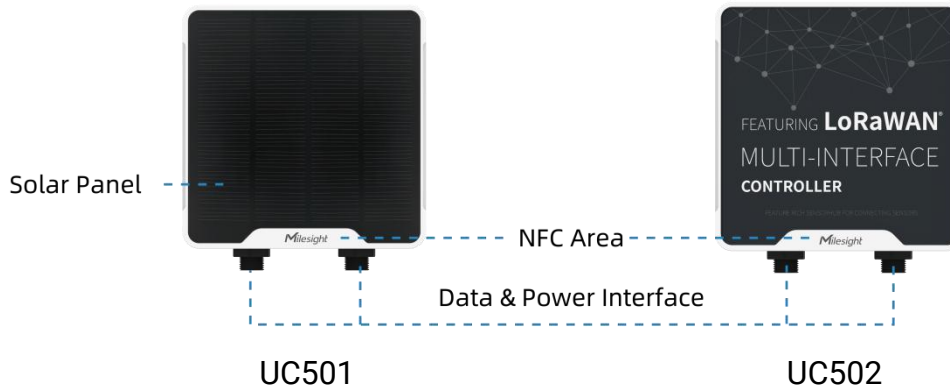

Data Interface 1:

Pin	Description
1	5V/9V/12V OUT (Switchable)
2	3.3V OUT
3	GND
4	Analog Input 1
5	Analog Input 2
6 ^{①②}	5-24V DC IN

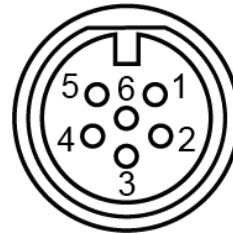

Data Interface 2:

Pin	Description	
1	5V/9V/12V OUT (Switchable)	
2	3.3V OUT	
3	GND	
4	GPIO1	
5	GPIO2	
6	RS232/RS485 (Switchable)	
7		
8	Reserved	
Pin	RS232	RS485
6	TXD	A
7	RXD	B

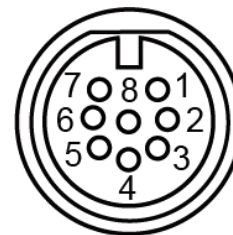

^① When both DC external power and batteries are connected, external power will be the preferred power supply option.

^② For UC502, the DC interface can't be to charge battery.

2.3 Internal Interfaces

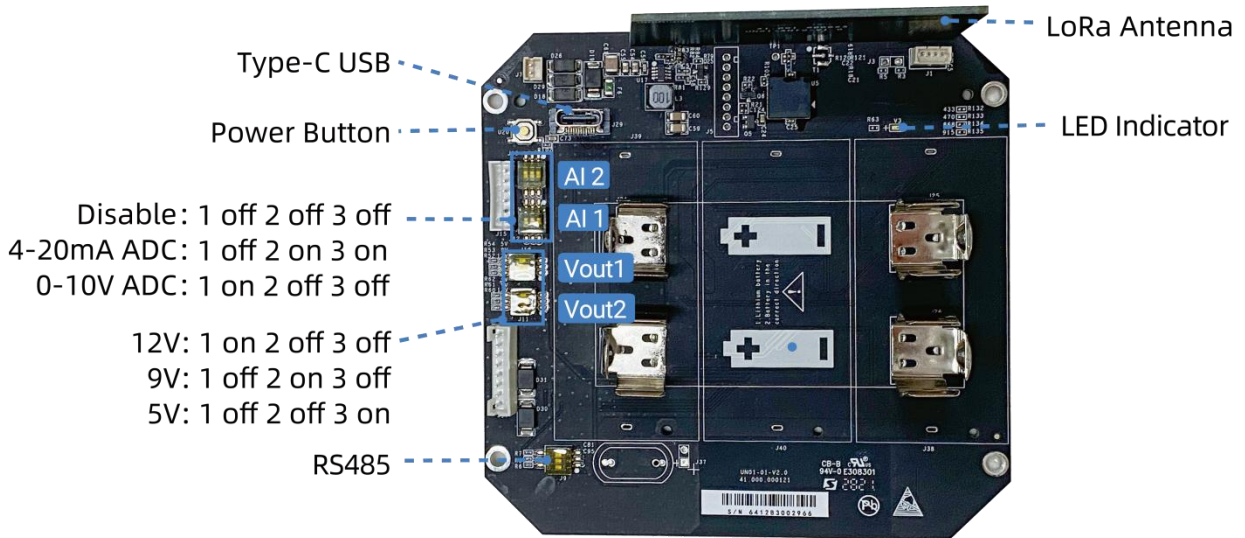

DIP Switch:

Interface	DIP Switch
Power Output	12V: 1 on 2 off 3 off 9V: 1 off 2 on 3 off 5V: 1 off 2 off 3 on
Analog Input	4-20mA ADC: 1 off 2 on 3 on 0-10V ADC: 1 on 2 off 3 off
RS485	Add 120 Ω resistor between A and B: 1 on 2 off 3 off Add 1k Ω pull-up resistor on A: 1 off 2 on 3 off Add 1k Ω pull-down resistor on B: 1 of 2 off 3 on

Note:

- 1) Analog inputs are set to 4-20mA by default, power outputs are set to 12V by default.
- 2) Power output on interface 1 is used for powering analog devices, power output on interface 2 is used for powering serial port devices.

Power Button:

Function	Action	LED Indication
Turn On	Press and hold the button for more than 3s.	Off → On
Turn Off	Press and hold the button for more than 3s.	On → Off
Reset	Press and hold the button for more than 10s.	Blinks.
Check On/Off Status	Quickly press the power button.	Light On: Device is on. Light Off: Device is off.

2.4 Dimensions (mm)

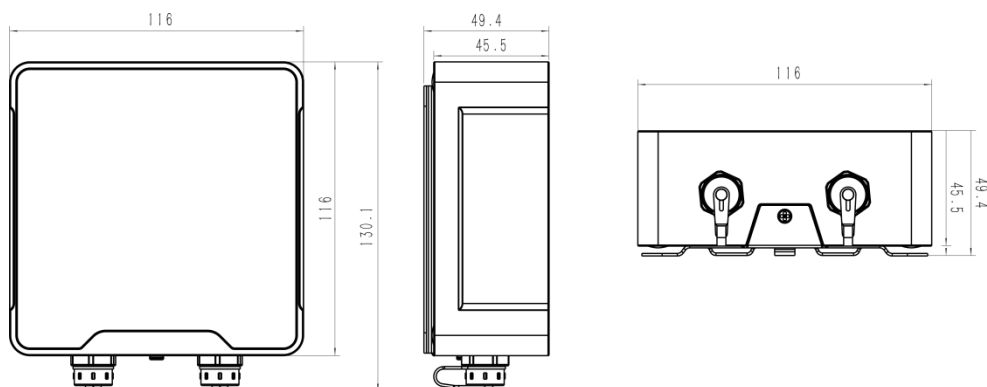

3. Hardware Switch

When using the analog input or power output of UC50x series, please follow the steps to switch the working mode of hardware interface:

1. Remove the screw caps and take off the roof cover.
2. Change DIP switches that are related analog inputs and power outputs as shown in [Section 2.3](#).
3. Put back the roof cover and screw the screws.

Note: turn off the device before changing DIP switches.

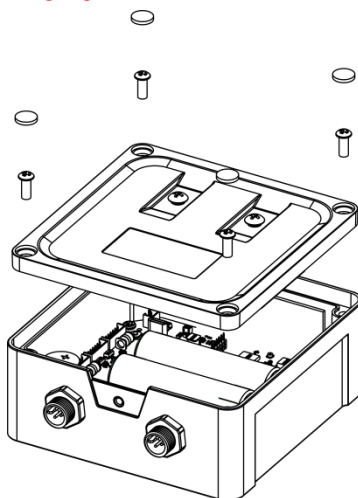

4. Operation Guide

4.1 Log in the ToolBox

UC50x series can be configured via NFC or Type-C port. Please select one of them to complete configuration.

4.1.1 NFC Configuration

1. Download and install “Milesight ToolBox” App from Google Play or Apple App Store.
2. Enable NFC on the smart phone and launch Milesight ToolBox.
3. Attach the smart phone with NFC area to the device to read device information.
4. Basic information and settings of the device will be shown on ToolBox App if it’s recognized successfully. You can read and configure the device by tapping the Read/Write device on the App. In order to protect the security of the device, password validation is required when first configuration. The default password is **123456**.



Note:

- 1) Ensure the location of smart phone NFC area and it’s recommended to take off phone case.
- 2) If the smart phone fails to read/write configurations via NFC, keep the phone away and back to try again.
- 3) UC50x series can also be configured by dedicated NFC reader, which can be purchased from Milesight IoT.

4.1.2 USB Configuration

1. Download ToolBox software from [Milesight IoT website](#).
2. Open the case of UC50x and connect the UC50x to computer via type-C port.

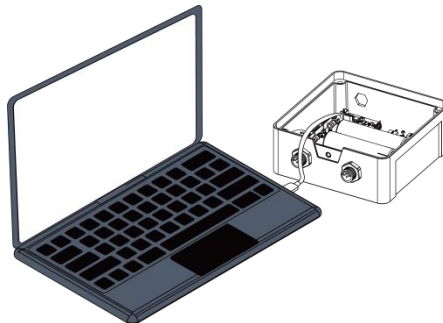

3. Open the ToolBox and select type as “General”, then click password to log in ToolBox. (Default password: **123456**)

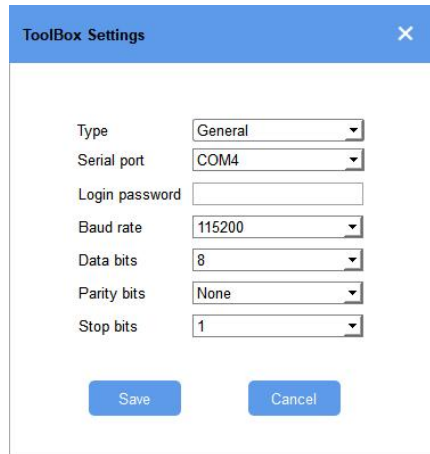

ToolBox Settings

Type: General

Serial port: COM4

Login password:

Baud rate: 115200

Data bits: 8

Parity bits: None

Stop bits: 1

Save Cancel

4. After logging in the ToolBox, you can click “Power On” or “Power Off” to turn on/off device and change other settings.



Status > Power On

Model:	UC501-915
Serial Number:	6412A4304414
Firmware Version:	01.01
Hardware Version:	2.1
Device Status:	Off
Join Status:	-
RSSI/SNR:	-
Battery:	-
Channel Mask:	-
Uplink Frame-counter:	-
Downlink Frame-counter:	-

4.2 LoRaWAN Settings

LoRaWAN settings is used for configuring the transmission parameters in LoRaWAN[®] network.

Basic LoRaWAN Settings:

Go to “**LoRaWAN -> Basic**” of ToolBox software or “**Setting -> LoRaWAN Settings**” for ToolBox App to configure join type, App EUI, App Key and other information. You can also keep all settings by default.

Device EUI	24E1244
App EUI	24E124C0002A0001
Application Port	85
Working Mode:	Class A
Join Type	OTAA
Application Key	*****
RX2 Date Rate	DR8 (SF12, 500k)
RX2 Frequency	923300000
Spread Factor	? SF7-DR3
Confirmed Mode	? <input type="checkbox"/>
Rejoin Mode	? <input checked="" type="checkbox"/>
Set the number of packets sent	32 packets
ADR Mode	? <input checked="" type="checkbox"/>
TXPower	TXPower0-22 dBm

Parameters	Description
Device EUI	Unique ID of the device which can also be found on the label.
App EUI	Default App EUI is 24E124C0002A0001.
Application Port	The port used for sending and receiving data, default port is 85. Note: RS232 data will be transmitted via another port.
Working Mode	UC501: Class A and Class C are available; UC502: Class A.
Join Type	OTAA and ABP mode are available.
Application Key	Appkey for OTAA mode, default is 5572404C696E6B4C6F52613230313823.
Device Address	DevAddr for ABP mode, default is the 5 th to 12 th digits of SN.
Network Session Key	Nwkskey for ABP mode, default is 5572404C696E6B4C6F52613230313823.
Application Session Key	Appskey for ABP mode, default is 5572404C696E6B4C6F52613230313823.
RX2 Data Rate	RX2 data rate to receive downlinks.

RX2 Frequency	RX2 frequency to receive downlinks. Unit: Hz
Spread Factor	If ADR is disabled, the device will send data via this spread factor.
Confirmed Mode	If the device does not receive ACK packet from network server, it will resend data once.
Rejoin Mode	Reporting interval \leq 30 mins: the device will send a specific number of LinkCheckReq MAC packets to the network server every 30 mins to validate connectivity; If there is no response, the device will re-join the network. Reporting interval $>$ 30 mins: the device will send a specific number of LinkCheckReq MAC packets to the network server every reporting interval to validate connectivity; If there is no response, the device will re-join the network.
ADR Mode	Allow network server to adjust datarate of the device.
Tx Power	Tx power of the device.

Note:

- 1) Please contact sales for device EUI list if there are many units.
- 2) Please contact sales if you need random App keys before purchase.
- 3) Select OTAA mode if you use Milesight IoT cloud to manage devices.
- 4) Only OTAA mode supports rejoin mode.

LoRaWAN Frequency Settings:

Go to “**LoRaWAN -> Channel**” of ToolBox software or “**Setting -> LoRaWAN Settings**” for ToolBox APP to select supported frequency and select channels to send uplinks. Make sure the channels match the LoRaWAN® gateway.

The screenshot shows the 'Channel' configuration page for the EU868 region. The 'Support Frequency' is set to EU868. Below is a table of channels:

<input type="checkbox"/>	Index	Frequency/MHz	Max Datarate	Min Datarate
<input checked="" type="checkbox"/>	0	868.1	5-SF7BW125	0-SF12BW125
<input checked="" type="checkbox"/>	1	868.3	5-SF7BW125	0-SF12BW125
<input checked="" type="checkbox"/>	2	868.5	5-SF7BW125	0-SF12BW125
<input type="checkbox"/>	3	0	5-SF7BW125	0-SF12BW125
<input type="checkbox"/>	4	0	5-SF7BW125	0-SF12BW125
<input type="checkbox"/>	5	0	5-SF7BW125	0-SF12BW125
<input type="checkbox"/>	6	0	5-SF7BW125	0-SF12BW125
<input type="checkbox"/>	7	0	5-SF7BW125	0-SF12BW125

If frequency is one of CN470/AU915/US915, you can enter the index of the channel that you want to enable in the input box, making them separated by commas.

Examples:

1, 40: Enabling Channel 1 and Channel 40

1-40: Enabling Channel 1 to Channel 40

1-40, 60: Enabling Channel 1 to Channel 40 and Channel 60

All: Enabling all channels

Null: Indicates that all channels are disabled

Support Frequency :

Enabled Channel Index:

Channel Index	Frequency/MHz	Channel Spacing/MHz	BW/kHz
0 - 15	915.2 - 918.2	0.2	125
16 - 31	918.4 - 921.4	0.2	125
32 - 47	921.6 - 924.6	0.2	125
48 - 63	924.8 - 927.8	0.2	125
64 - 71	915.9 - 927.1	1.6	500

Note:

For -868M model, default frequency is EU868;

For -915M model, default frequency is AU915.

4.3 Interface Settings

UC50x series support data collection by multiple interfaces including GPIOs, analog inputs and serial ports. Besides, it can also power the terminal devices by power output interfaces. Basic settings are as follows:

Go to "**General -> Basic**" of ToolBox software or "**Setting -> General Settings**" page to change the reporting interval.

Reporting Interval s

The device returns to the power supply state

Change Password

Parameters	Description
Reporting Interval	Reporting interval of transmitting data to network server. Default: 1200s (20 mins), Range: 30-64800s. Note: RS232 transmission will not follow the reporting interval.
The device returns to the power supply state	If the device loses power and return to power supply, the device will be on or off according to this parameter.
Change Password	Change the password for ToolBox APP or software to read/write this device.

4.3.1 RS485 Settings

1. Connect RS485 device to RS485 port on interface 2. If you need UC50x to power the RS485 device, please connect the power cable of RS485 device to 5V/9V/12V or 3.3V power output on interface 2.
2. Go to "**General -> Serial**" of ToolBox software or "**Setting -> Serial Setting**" to enable RS485 and configure serial port settings. Serial port settings should be the **same** as RS485 terminal devices.

Enable	<input checked="" type="checkbox"/>
Interface Type	RS485 (Modbus Master) ▾
Interface 2 (Pin1) 5/9/12V Output	<input type="checkbox"/>
Interface 2 (Pin2) 3.3V Output	<input type="checkbox"/>
Baud Rate	9600 ▾
Data Bit	8 bits ▾
Stop Bit	1 bits ▾
Parity	None ▾
Execution Interval	3 ms
Max Resp Time	600 ms
Max Retry Times	0
Modbus RS485 bridge LoRaWAN	<input checked="" type="checkbox"/>
Port	0

Parameters	Description
Interface 2(Pin 1) 5V/9V/12V Output	Enable 5V/9V/12V power output of interface 2 to supply power to RS485 terminal devices. It's 12V by default and you can change DIP switches to change voltage.
Power Output Time Before Collect	5V/9V/12V power output will power the RS485 terminal devices for a period of time before collecting data for terminal device initialization. Range: UC501 is 0-600s, UC502 is 0-10s.
Interface 2(Pin 2) 3.3V Output	Enable 3.3V power output of interface 2 to supply power to RS485 terminal devices.
Power Supply Mode	Select "Continuous power supply" or "Configurable power supply time". When you select "Configurable power supply time", the time range is 0-600s.
Baud Rate	1200/2400/4800/9600/19200/38400/57600/115200 are available.
Data Bit	8 bit is available.
Stop Bit	1 bit/2 bit are available.
Parity	None, Odd and Even are available.
Execution Interval	The execution interval between each Modbus command.
Max Resp Time	The maximum response time that the UC50x waits for the reply to the command. If it does not get a response after the max response time, it is determined that the command has timed out.
Max Retry Time	Set the maximum retry times after device fails to read data from RS485 terminal devices.
Modbus RS485 bridge LoRaWAN	If this mode is enabled, UC50x will transparent Modbus RTU commands from network server to RS485 terminal devices and send Modbus reply originally back to network server. Port: Select from 2-84, 86-223.

Note: When you use power output to power RS485 Modbus slave devices, it only supplies power when reporting interval is coming. It's suggested to power slave devices with external power during the PoC test.

3. Click  to add Modbus channels, then save configurations.

Channel Settings
Fetch All

Channel ID	Name	Slave ID	Address	Quantity	Type	Byte Order	Sign	Value			
1	1	1	0	1	Input Register(INT16)	AB	<input type="checkbox"/>		<input checked="" type="checkbox"/>	Fetch	<input type="checkbox"/>
2	test	255	5535	2	Coil		<input checked="" type="checkbox"/>		<input checked="" type="checkbox"/>	Fetch	+ <input type="checkbox"/>

Save
Up to 16 channels

Parameters	Description
Channel ID	Select the channel ID you want to configure, 16 channels selectable.
Name	Customize the name to identify every Modbus channel.
Slave ID	Set Modbus slave ID of terminal device.
Address	The starting address for reading.
Quantity	Set read how many digits from starting address. It fixes to 1.
Type	Select data type of Modbus channels.
Byte Order	Set the Modbus data reading order if you configure the type as Input Register or Holding Register. INT32/Float: ABCD, CDBA, BADC, DCBA INT16: AB,BA
Sign	The tick indicates that the value has a plus or minus sign.
Fetch	After click, the device will send Modbus read command to test if it can read correct values. Example: as this setting, the device will send command: 01 03 00 00 00 01 84 0A

Channel Settings
Fetch All

Channel ID	Name	Slave ID	Address	Quantity	Type	Byte Order	Sign	Value			
1	temperature	1	0	1	Holding Register(INT16)	AB	<input type="checkbox"/>		<input checked="" type="checkbox"/>	Fetch	<input type="checkbox"/>

4. For ToolBox software, click “Fetch” to check if UC50x can read correct data from terminal devices. You can also click “Fetch” on the top of list to fetch all channel data.

Channel Settings
Fetch All

Channel ID	Name	Slave ID	Address	Quantity	Type	Byte Order	Sign	Value			
1	1	1	0	1	Input Register(INT16)	AB	<input type="checkbox"/>		<input checked="" type="checkbox"/>	Fetch	<input type="checkbox"/>
2	test	255	5535	2	Coil		<input checked="" type="checkbox"/>		<input checked="" type="checkbox"/>	Fetch	+ <input type="checkbox"/>

Save
Up to 16 channels

Note: do not click “Fetch” frequently since response time to reply is differ for every terminal device.

For ToolBox App,

- a. Tap every Modbus channel, click “Collect” and attach smart phone to device to make device collect data.
- b. Click “Fetch” and attach smart phone to make App read the data. You can also tap “Collect All” and “Fetch All” to fetch all channel data.

← 1

* Name
1

Slave ID - 1 +

Address - 0 +

Quantity 1

Type
Holding Register (INT32)

Byte Order
ABCD

Sign

Value

4.3.2 RS232 Settings

1. Connect RS232 device to RS232 port on interface 2. If you need UC501 to power the RS232 device, connect the power cable of RS232 device to power output on interface 2.
2. Go to “**General -> Serial**” of ToolBox software or “**Setting -> Serial Setting**” to enable RS232 and configure serial port settings. Serial port settings should be the **same** as RS232 terminal devices.

Enable	<input checked="" type="checkbox"/>
Interface Type	RS232
Interface 2 (Pin1) 5/9/12V Output	<input checked="" type="checkbox"/>
Interface 2 (Pin2) 3.3V continuous Output	<input type="checkbox"/>
Baud Rate	9600
Data Bit	8 bits
Stop Bit	1 bits
Parity	None
Port	86

Parameters	Description
Interface 2(Pin 1) 5V/9V/12V Output	Enable 5V/9V/12V power output of interface 2 to supply power to RS232 terminal devices continuously . Only UC501 supports this feature. Note: Power output is 12V by default and you can change DIP switches to change voltage.
Interface 2(Pin 2) 3.3V Continuous Output	Enable 3.3V power output of interface 2 to supply power to RS232 terminal devices continuously .
Baud Rate	300/1200/2400/4800/9600/19200/38400/57600/115200 are available.
Data Bit	8 bit is available.
Stop Bit	1 bit/2 bit are available.
Parity	None, Odd and Even are available.
Port	The port used for RS232 data transmission.

4.3.3 GPIO Settings

1. Connect devices to GPIO ports on interface 2.
2. Go to "**General -> GPIO**" of ToolBox software or "**Setting -> GPIO Setting**" to enable GPIO port.

Interface Name	GPIO 1		
Enable	<input checked="" type="checkbox"/>		
Interface Type	Digital Output1		
Status	<input type="text"/>	Fetch	Switch
Interface Name	GPIO 2		
Enable	<input checked="" type="checkbox"/>		
Interface Type	Digital Output2		
Status	<input type="text"/>	Fetch	Switch
Save			

3. Select GPIO type according to your requirements.

Digital Input:

Digital input can be used to detect high or low status of devices.

Interface Name	GPIO 1		
Enable	<input checked="" type="checkbox"/>		
Interface Type	Digital Input1		
Digital Input	<input type="text"/>	<input type="text"/>	<input type="text"/>
Status	<input type="text"/>	<input checked="" type="checkbox"/>	Fetch

Parameters	Description
Digital Input	Initial status of digital input. Pull Down: rising edge will be triggered Pull Up/None: falling edge will be triggered
Fetch	Click to get current status of digital input.

Digital Output:

Digital output will send voltage signals to control devices.

Interface Name	GPIO 2	
Enable	<input checked="" type="checkbox"/>	
Interface Type	Digital Output2	
Status	Low	Fetch Switch

Parameters	Description
Fetch	Click to get current status of digital output.
Switch	Click to switch the digital output status to check if UC50x can trigger devices.

Pulse Counter:

Interface Name	GPIO 1	
Enable	<input checked="" type="checkbox"/>	
Interface Type	Counter	
Digital Input	<input type="checkbox"/> ?	Pull Down
Digital Filter	<input checked="" type="checkbox"/> ?	
keep last value when power off	<input type="checkbox"/>	
Counter values	0	Refresh Start Clear
Modify the count values		

Parameters	Description
Digital Input	Initial status of counter. Pull Down: Increase 1 when detecting rising edge Pull Up/None: Increase 1 when detecting falling edge
Digital Filter	It's recommended to enable when pulse period is greater than 250 us.
Keep last value when power off	Keep the counted values when the device powers off.
Start/Stop	Make the device start/stop counting. Note: UC50x will send non-changable counting values if you do not click "Start".
Refresh	Refresh to get latest counter values.
Clear	Count the value from 0.
Modify the count values	Set the initial counting value.

4.3.4 AI Settings

1. Connect analog device to analog input ports on interface 1. If you need UC50x to power the analog device, connect the power cable of analog device to power output on interface 1.

2. Go to “**General -> AI**” of ToolBox software or “**Setting -> AI Setting**” to enable analog input and select the analog type.

Note: Ensure [DIP switches](#) has changed if you need to use 0-10V mode.

Interface Name	Analog Input 1	
Enable	<input checked="" type="checkbox"/>	
Analog Input Signal Type	<input type="text" value="4-20 mA"/>	
Status	<input type="text" value=""/>	<input type="button" value="Fetch"/>
Interface Name	Analog Input 2	
Enable	<input checked="" type="checkbox"/>	
Analog Input Signal Type	<input type="text" value="0-10 V"/>	
Status	<input type="text" value=""/>	<input type="button" value="Fetch"/>

3. Enable “Interface 1 (Pin 1) 5V/9V/12V Output” or “Interface 1 (Pin 2) 3.3V Output” and configure “Power Output Time Before Collect”, UC50x will power the analog devices for a period of time before collecting data.

Note: When you use power output to power analog devices, it only supplies power when reporting interval is coming. It's suggested to power slave devices with external power during the PoC test.

Interface 1 (Pin1) 5/9/12V Output	<input checked="" type="checkbox"/>	
Power Output Time Before Collect	<input type="text" value="0"/>	s
Interface 1 (Pin2) 3.3V Output	<input checked="" type="checkbox"/>	
Power Supply Mode	<input type="text" value="Configurable power supply tim"/>	
Power Output Time Before Collect	<input type="text" value="0"/>	s

4. For ToolBox software, click “Fetch” to check if UC50x can read correct data from analog devices.

Interface Name	Analog Input 2
Enable	<input checked="" type="checkbox"/>
Analog Input Signal Type	0-10 V
Status	0.00 V <input checked="" type="checkbox"/> <input type="button" value="Fetch"/>

For ToolBox App,

- Click "Collect" and attach smart phone to device to make device collect data.
- Click "Fetch" and attach smart phone to make APP read the data.

AI Settings	^
Interface 2(Pin 1) 5/9/12V	<input type="checkbox"/>
Analog Input 1	<input checked="" type="checkbox"/>
Analog input Signal Type	4-20mA
Status	- mA <input type="button" value="Collect"/>

4.4 Maintenance

4.4.1 Upgrade

ToolBox Software:

- Download firmware from www.milesight-iot.com to your PC.
- Go to "**Maintenance -> Upgrade**" of ToolBox software, click "**Browse**" to import firmware and upgrade the device. You can also click "**Up to Date**" to search for the latest firmware of the device and upgrade.

<input type="button" value="Upgrade"/> <input type="button" value="Backup and Reset"/>	
Model:	UC502-868M
Firmware Version:	01.07
Hardware Version:	2.1
Domain:	Beijing Server
FOTA:	<input type="button" value="Up to date"/>
Update Locally	<input type="text"/> <input type="button" value="Browse"/> <input type="button" value="Upgrade"/>

ToolBox App:

1. Download firmware from www.milesight-iot.com to your smart phone.
2. Open ToolBox App and click "Browse" to import firmware and upgrade the device.

Note:

- 1) Operation on ToolBox is not supported during the upgrade.
- 2) Only Android version ToolBox supports the upgrade feature.

Status	Setting	Maintenance
SN		6412B3029235
Model		UC501-868M
Firmware Version		V1.2
Hardware Version		V2.0
Manual Upgrade		
<input type="button" value="Browse"/>		

4.4.2 Backup

UC50x devices support configuration backup for easy and quick device configuration in bulk. Backup is allowed only for devices with the same model and LoRa frequency band. Please select one of following methods to backup device:

ToolBox Software:

1. Go to "**Maintenance -> Backup and Reset**", click "Export" to save current configuration as json format backup file.
2. Click "Browse" to select backup file, then click "Import" to import the configurations.

Upgrade	Backup and Reset	
	<input type="button" value="Export"/>	
	<input type="text"/> <input type="button" value="Browse"/> <input type="button" value="Import"/>	
	<input type="button" value="Reset"/>	

ToolBox App:

1. Go to "Template" page on the App and save current settings as a template. You can also edit the template file.
2. Select one template file which saved in the smart phone and click "Write", then attach to another device to write configuration.

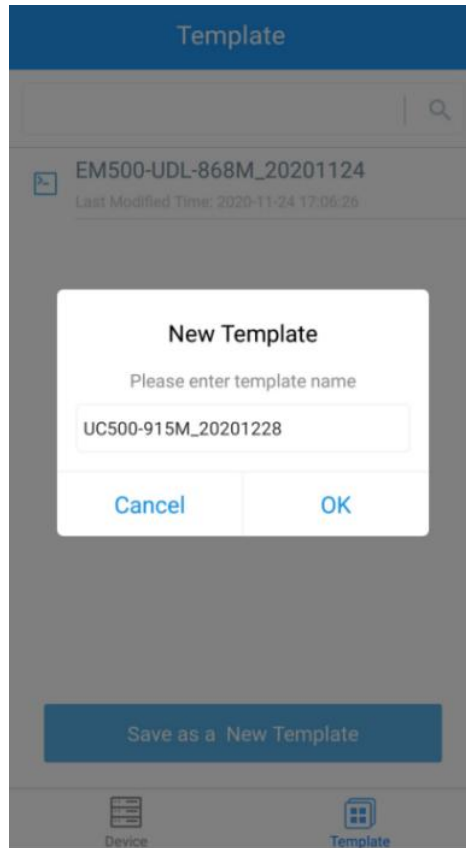

4.4.3 Reset to Factory Default

Please select one of following methods to reset device:

Via Hardware: Open the case of UC50x and hold on power button more than 10s.

Via ToolBox Software: Go to "**Maintenance -> Backup and Reset**" to click "Reset".

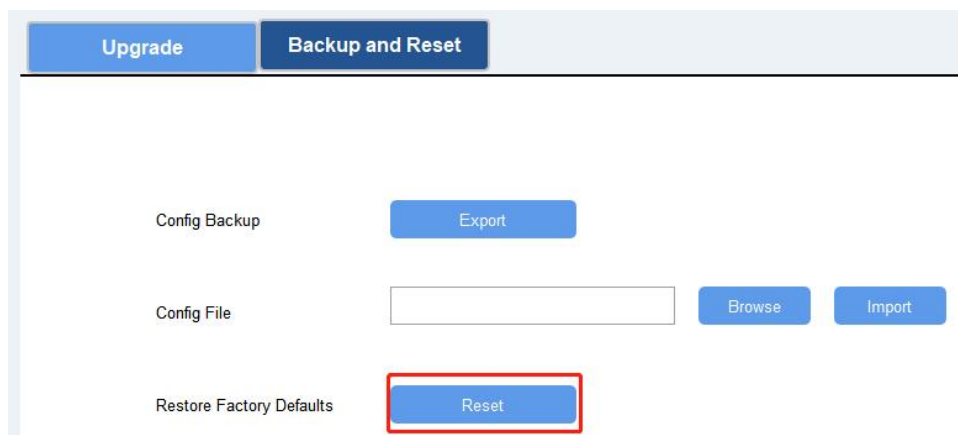

Via ToolBox App: Go to “**Device -> Maintenance**” to click “Reset”, then attach smart phone with NFC area to UC50x to complete reset.

Status	Setting	Maintenance
SN	6412B3029235	
Model	UC501-868M	
Firmware Version	V1.2	
Hardware Version	V2.0	
Manual Upgrade		
Browse		
Restore Factory Default		
Reset		

5. Installation

UC50x series support wall mounting or pole mounting. Before installation, make sure you have the mounting bracket, wall or pole mounting kits and other required tools.

Wall Mounting:

1. Fix the wall plugs into the wall, then fix the mounting bracket to the wall plugs with screws.
2. Put the device on the mounting bracket, then fix the bottom of the device to the bracket with a fixing screw. It's necessary to fix this bracket to device, or it will affect the signal.

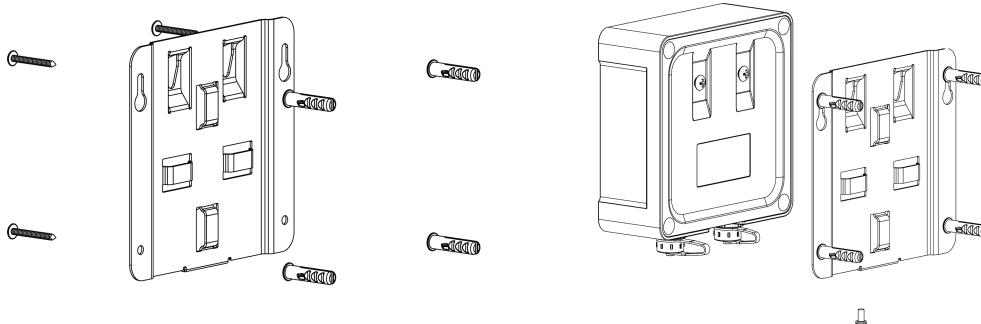

Pole Mounting:

1. Straighten out the hose clamp and slide it through the rectangular rings in the mounting bracket, wrap the hose clamp around the pole. After that use a screwdriver to tighten the locking mechanism by turning it clockwise.

- Put the device on the mounting bracket, then fix the bottom of the device to the bracket with a fixing screw. It's necessary to fix this bracket to device, or it will affect the signal.



6. Milesight IoT Cloud Management

UC50x series can be managed by Milesight IoT Cloud platform. Milesight IoT cloud is a comprehensive platform that provides multiple services including device remote management and data visualization with the easiest operation procedures. Please register a Milesight IoT Cloud account before operating following steps.

- Ensure Milesight LoRaWAN® gateway is online in Milesight IoT Cloud. For more info about connecting gateway to cloud please refer to gateway's user guide.

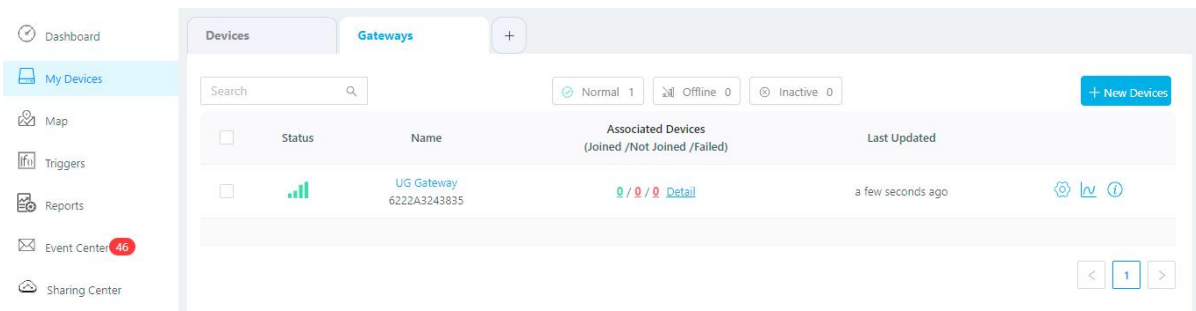

- Go to "My Devices" page and click "+New Devices". Fill in the SN of UC50x and select associated gateway.

Add Device ✕

* SN:

* Name:

* Associated Gateway:

* Device EUI:

* Application Key:

3. For UC501, click  and go to “Basic Settings” to change class type the same as device settings.

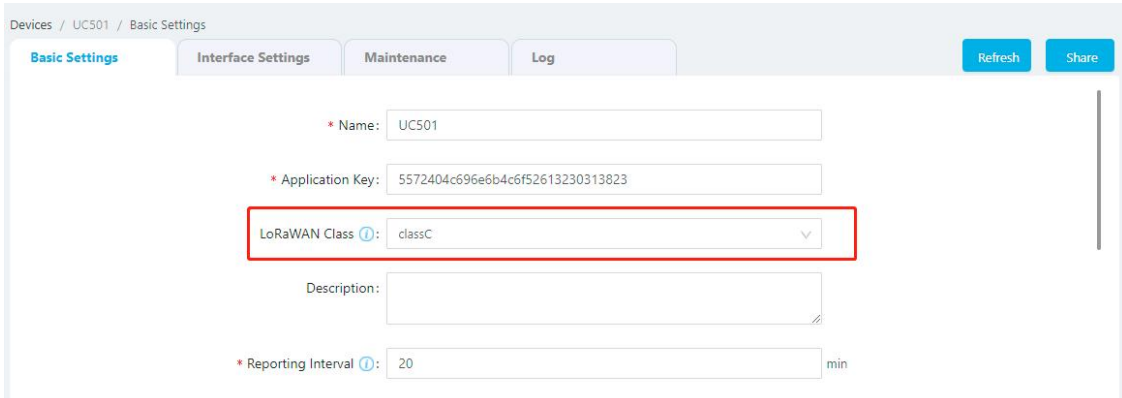

Devices / UC501 / Basic Settings

Basic Settings | Interface Settings | Maintenance | Log

* Name: UC501

* Application Key: 5572404c696e6b4c6f52613230313823

LoRaWAN Class: classC

Description:

* Reporting Interval: 20 min

Refresh | Share

4. After UC50x is online in Milesight IoT Cloud, click  and go to “Interface Settings” to select used interfaces and customize the name, sign and formulas.

Note: Modbus channel settings should be the same as the configuration in Toolbox.

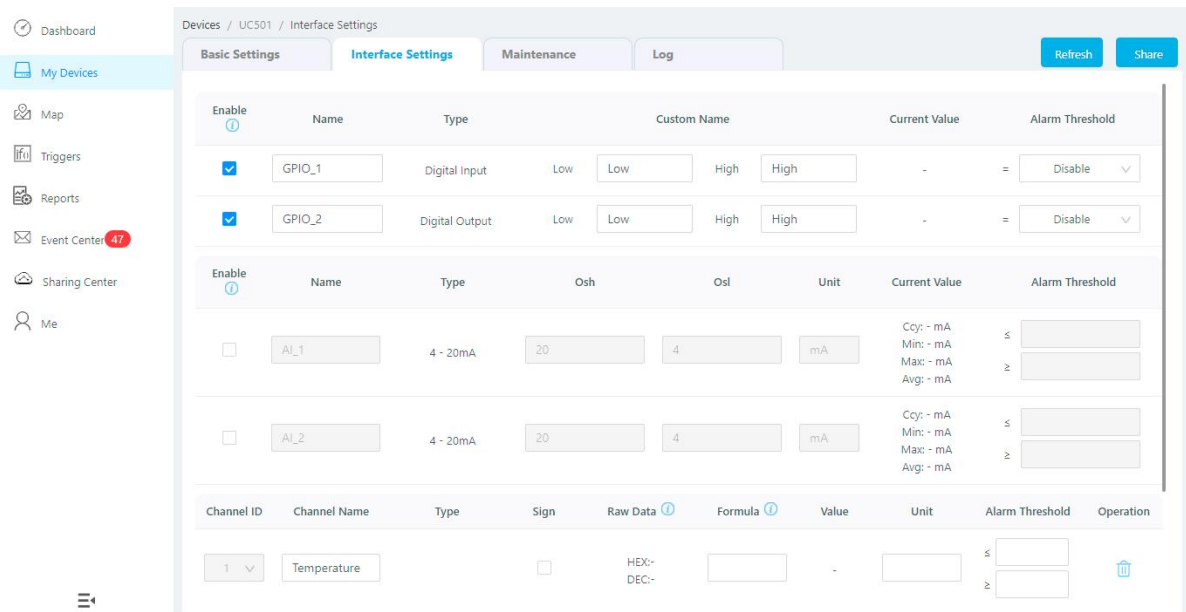

Dashboard

My Devices

Map

Triggers

Reports

Event Center 47

Sharing Center

Me

Devices / UC501 / Interface Settings

Basic Settings | Interface Settings | Maintenance | Log

Refresh | Share

Enable	Name	Type	Custom Name		Current Value	Alarm Threshold			
<input checked="" type="checkbox"/>	GPIO_1	Digital Input	Low	Low	High	High	-	=	Disable
<input checked="" type="checkbox"/>	GPIO_2	Digital Output	Low	Low	High	High	-	=	Disable

Enable	Name	Type	Osh	Osl	Unit	Current Value	Alarm Threshold	
<input type="checkbox"/>	AL_1	4 - 20mA	20	4	mA	Coy: - mA Min: - mA Max: - mA Avg: - mA	≤	
<input type="checkbox"/>	AL_2	4 - 20mA	20	4	mA	Coy: - mA Min: - mA Max: - mA Avg: - mA	≤	

Channel ID	Channel Name	Type	Sign	Raw Data	Formula	Value	Unit	Alarm Threshold	Operation
1	Temperature		<input type="checkbox"/>	HEX:- DEC:-		-		≤	
								≥	

7. Device Payload

UC50x Series use the standard Milesight IoT payload format based on IPSO. Please refer to the *UC50x Series Communication Protocol*, for decoders of Milesight IoT products please click [here](#).

-END-