



LoRaWAN[®] Controller

UC50x Series

User Guide



Safety Precautions

Milesight will not shoulder responsibility for any loss or damage resulting from not following the instructions of this operating guide.

- ❖ The device must not be remodeled in any way.
- ❖ Do not place the device close to objects with naked flames.
- ❖ Do not place the device where the temperature is below/above the operating range.
- ❖ Make sure electronic components do not drop out of the enclosure while opening.
- ❖ When installing the battery, please install it accurately, and do not install the reverse or wrong model.
- ❖ Make sure both batteries are newest when install, or battery life will be reduced.
- ❖ The device must never be subjected to shocks or impacts.

Declaration of Conformity

UC50x series is in conformity with the essential requirements and other relevant provisions of the CE, FCC, and RoHS.



Copyright © 2011-2023 Milesight. All rights reserved.

All information in this guide is protected by copyright law. Whereby, no organization or individual shall copy or reproduce the whole or part of this user guide by any means without written authorization from Xiamen Milesight IoT Co., Ltd.

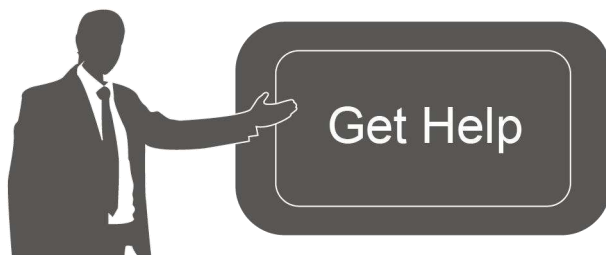

For assistance, please contact

Milesight technical support:

Email: iot.support@milesight.com

Support Portal: support.milesight-iot.com

Tel: 86-592-5085280

Fax: 86-592-5023065

Address: Building C09, Software Park III,
Xiamen 361024, China

Revision History

Date	Doc Version	Description
Dec. 9, 2021	V 2.0	Initial version based on hardware 2.0
June 16, 2022	V 2.1	Update 3.3V power output feature
Nov. 21, 2022	V 2.2	1. Add RS485 byte order feature 2. Add GPIO initial counting value modification feature
July 7, 2023	V 3.0	Initial version based on hardware 3.x

Contents

1. Product Introduction	5
1.1 Overview	5
1.2 Features	5
2. Hardware Introduction	5
2.1 Packing List	5
2.2 Hardware Overview	6
2.3 Internal Interfaces	7
2.4 Dimensions (mm)	8
3. Hardware Switch	8
4. Operation Guide	9
4.1 Log in the ToolBox	9
4.1.1 NFC Configuration	9
4.1.2 USB Configuration	10
4.2 LoRaWAN Settings	11
4.2.1 Basic Settings	11
4.2.1 Frequency Settings	13
4.2.3 Multicast Settings (UC501 Only)	14
4.3 Interface Settings	16
4.3.1 Basic Settings	16
4.3.2 Analog Input	17
4.3.3 RS485	19
4.3.4 RS232	22
4.3.5 GPIO	23
4.3.6 SDI-12	25
4.4 Alarm Settings	27
4.5 Data Storage	29
4.6 Data Retransmission	30
4.7 Maintenance	31
4.7.1 Upgrade	31
4.7.2 Backup	32
4.7.3 Reset to Factory Default	34
5. Installation	34
6. Milesight IoT Cloud Management	35
7. Device Payload	37

1. Product Introduction

1.1 Overview

UC50x series is a LoRaWAN® controller used for data acquisition from multiple sensors. It contains different I/O interfaces such as analog inputs, digital inputs, digital outputs, serial ports and so on, which simplify the deployment and replacement of LoRaWAN® networks.

UC50x series can be easily and quickly configured by NFC or wired USB port. For outdoor applications, it provides solar or built-in battery power supply and is equipped with IP67-rated enclosure and M12 connectors to protect itself from water and dust in harsh environments.

1.2 Features

- Easy to connect with multiple wired sensors through GPIO/AI/RS232/RS485/SDI-12 interfaces
- Long transmission distance up to 15 km with line of sight
- Waterproof design including IP67 case and M12 connectors
- Solar powered and built-in battery optional
- Quick wireless configuration via NFC
- Compliant with standard LoRaWAN® gateways and network servers
- Quick and easy management with Milesight IoT Cloud solution
- Supports multicast for control in bulk

2. Hardware Introduction

2.1 Packing List



1 × UC50x
Device



2 × Data Cables
(30 cm)

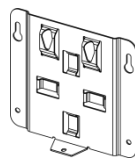

1 × Mounting
Bracket



4 × Wall
Mounting Kits



2 ×
Hose Clamps



1 × Fixing
Screw



1 ×
Quick Guide



1 ×
Warranty Card



1 × LoRaWAN®
Magnetic Antenna

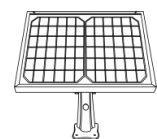

1 × Solar Panel Kit
(Optional)

(EA Version Only)

! If any of the above items is missing or damaged, please contact your sales Representative.

2.2 Hardware Overview

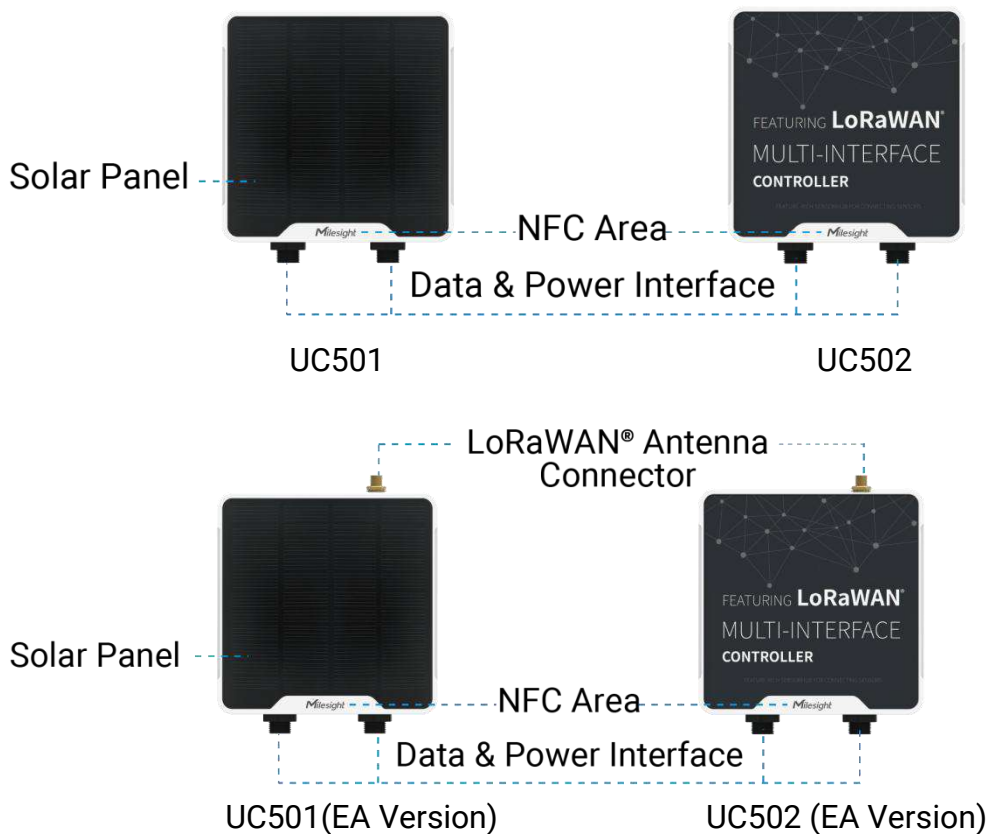

Data Interface 1:

Pin	Description
1	5V/9V/12V OUT (Switchable)
2	3.3V OUT
3	GND
4	Analog Input 1
5	Analog Input 2
6 ^{①②}	5-24V DC IN

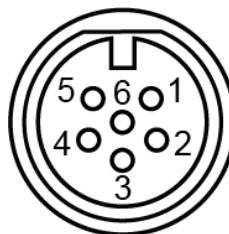

^① When both DC external power and batteries are connected, external power will be the preferred power supply option.

^② For UC502, the DC interface can't be to charge battery.

Data Interface 2:

Pin	Description	
1	5V/9V/12V OUT (Switchable)	
2	3.3V OUT	
3	GND	
4	GPIO1	
5	GPIO2	
6	RS232/RS485 (Switchable)	
7		
8	SDI-12	
Pin	RS232	RS485
6	TXD	A
7	RXD	B

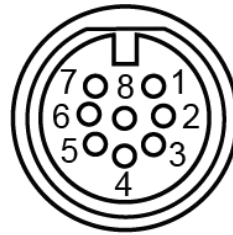

2.3 Internal Interfaces

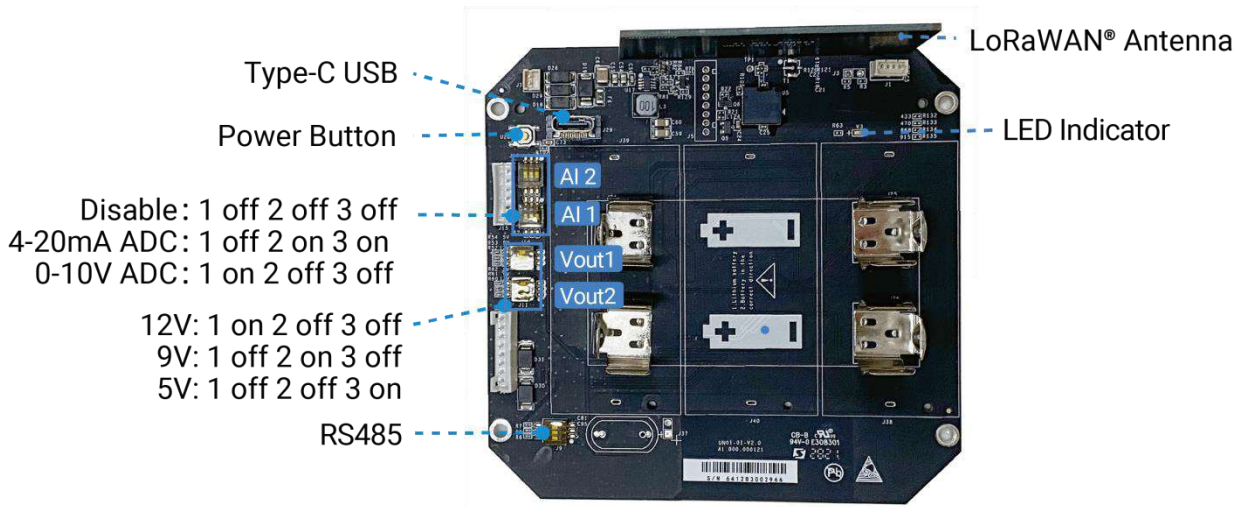

DIP Switch:

Interface	DIP Switch
Power Output	12V: 1 on 2 off 3 off 9V: 1 off 2 on 3 off 5V: 1 off 2 off 3 on
Analog Input	4-20mA ADC: 1 off 2 on 3 on 0-10V ADC: 1 on 2 off 3 off
RS485	Add 120 Ω resistor between A and B: 1 on 2 off 3 off Add 1k Ω pull-up resistor on A: 1 off 2 on 3 off Add 1k Ω pull-down resistor on B: 1 of 2 off 3 on

Note:

- 1) Analog inputs are set to 4-20mA by default, power outputs are set to 12V by default.
- 2) Power output on interface 1 is used for powering analog devices, power output on interface 2 is used for powering serial port devices and SDI-12 devices.

Power Button:

Function	Action	LED Indication
Turn On	Press and hold the button for more than 3s.	Off → On
Turn Off	Press and hold the button for more than 3s.	On → Off
Reset	Press and hold the button for more than 10s.	Blinks.
Check On/Off Status	Quickly press the power button.	Light On: Device is on. Light Off: Device is off.

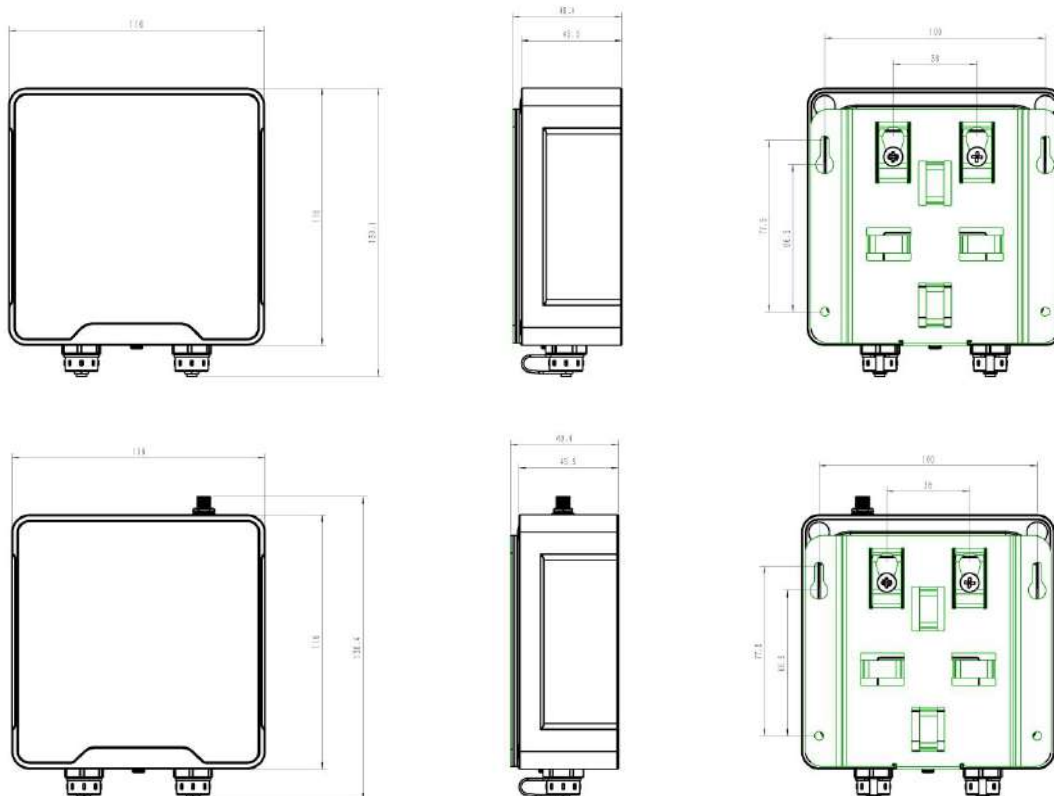
2.4 Dimensions (mm)**3. Hardware Switch**

When using the analog input or power output of UC50x series, please follow the steps to switch the working mode of hardware interface:

1. Remove the screw caps and take off the roof cover.
2. Change DIP switches that are related analog inputs and power outputs as shown in [Section 2.3](#).
3. Put back the roof cover and screw the screws.

Note: turn off the device before changing DIP switches.

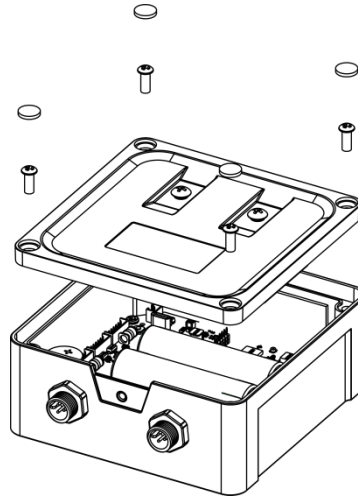

4. Operation Guide

4.1 Log in the ToolBox

UC50x series can be configured via NFC or Type-C port. Please select one of them to complete configuration.

4.1.1 NFC Configuration

1. Download and install **Milesight ToolBox** App from Google Play or Apple App Store.
2. Enable NFC on the smart phone and launch Milesight ToolBox.
3. Attach the smart phone with NFC area to the device, click **NFC read** to read device information.
4. Basic information and settings of the device will be shown on ToolBox App if it's recognized successfully. You can read and configure the device by tapping the Read/Write device on the App. In order to protect the security of the device, password validation is required when first configuration. The default password is **123456**.



Note:

- 1) Ensure the location of smart phone NFC area and it's recommended to take off phone case.
- 2) If the smart phone fails to read/write configurations via NFC, keep the phone away and back to try again.
- 3) UC50x series can also be configured by dedicated NFC reader, which can be purchased from Milesight IoT.

4.1.2 USB Configuration

1. Download ToolBox software from Milesight official website.
2. Open the case of UC50x and connect the UC50x to computer via type-C port.

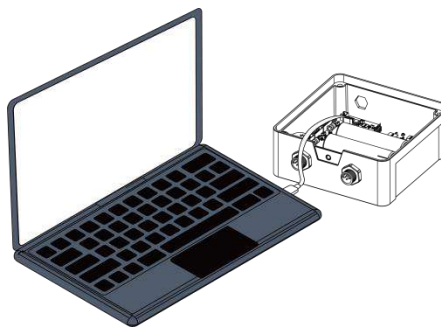

3. Open the ToolBox and select type as **General**, then click password to log in ToolBox. (Default password: **123456**)

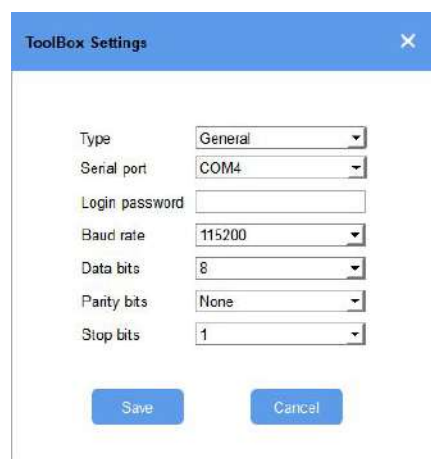

4. After logging in the ToolBox, you can click **Power On** or **Power Off** to turn on/off device and change other settings.

Status

General

LoRaWAN Settings

Status > Power On

Model:	UC501-915
Serial Number:	6412A4304414
Firmware Version:	01.01
Hardware Version:	2.1
Device Status:	Off
Join Status:	-
RSSI/SNR:	-
Battery:	-
Channel Mask:	-
Uplink Frame-counter:	-
Downlink Frame-counter:	-

4.2 LoRaWAN Settings

LoRaWAN settings is used for configuring the transmission parameters in LoRaWAN® network.

4.2.1 Basic Settings

UC50x supports basic configurations like join type, App EUI, App Key and other information. You can also keep all settings by default.

Device EUI	<input type="text" value="24E124454D100844"/>
App EUI	<input type="text" value="24E124C0002A0001"/>
Application Port	<input type="text" value="85"/>
Working Mode:	<input type="text" value="Class A"/>
LoRaWAN Version	<input type="text" value="V1.0.3"/>
Join Type	<input type="text" value="OTAA"/>
Application Key	<input type="text" value="*****"/>
RX2 Date Rate	<input type="text" value="DR0 (SF12, 125 kHz)"/>
RX2 Frequency	<input type="text" value="505300000"/>
Spread Factor	<input type="text" value="SF10-DR2"/>
Confirmed Mode	<input type="checkbox"/>
Rejoin Mode	<input checked="" type="checkbox"/>
Set the number of packets sent	<input type="text" value="32"/> packets
ADR Mode	<input checked="" type="checkbox"/>
TXPower	<input type="text" value="TXPower0-19.15 dBm"/>

Parameters	Description
Device EUI	Unique ID of the device which can also be found on the label.
App EUI	Default App EUI is 24E124C0002A0001.
Application Port	The port used for sending and receiving data, default port is 85. Note: RS232 data will be transmitted via another port.
Working Mode	UC501: Class A and Class C are available; UC502: Class A.
LoRaWAN Version	V1.0.2, V1.0.3 are available.
Join Type	OTAA and ABP mode are available.
Application Key	Appkey for OTAA mode, default is 5572404C696E6B4C6F52613230313823.
Device Address	DevAddr for ABP mode, default is the 5 th to 12 th digits of SN.
Network Session Key	Nwkskey for ABP mode, default is 5572404C696E6B4C6F52613230313823.
Application Session Key	Appskey for ABP mode, default is 5572404C696E6B4C6F52613230313823.
RX2 Data Rate	RX2 data rate to receive downlinks.
RX2 Frequency	RX2 frequency to receive downlinks. Unit: Hz
Spread Factor	If ADR is disabled, the device will send data via this spread factor.
Confirmed Mode	If the device does not receive ACK packet from network server, it will resend data once.
Rejoin Mode	Reporting interval \leq 35 mins: the device will send a specific number of LinkCheckReq MAC packets to the network server every reporting interval or 2*reporting interval to validate connectivity; If there is no response, the device will re-join the network. Reporting interval $>$ 35 mins: the device will send a specific number of LinkCheckReq MAC packets to the network server every reporting interval to validate connectivity; If there is no response, the device will re-join the network.
Set the number of packets sent	When rejoin mode is enabled, set the number of LinkCheckReq packets sent. Note: the actual sending number is Set the number of packet sent + 1 .
ADR Mode	Allow network server to adjust datarate of the device.
Tx Power	Tx power of the device.

Note:

- 1) Please contact sales for device EUI list if there are many units.
- 2) Please contact sales if you need random App keys before purchase.
- 3) Select OTAA mode if you use Milesight IoT cloud to manage devices.
- 4) Only OTAA mode supports rejoin mode.

4.2.1 Frequency Settings

Select supported frequency and select channels to send uplinks. Make sure the channels match the LoRaWAN® gateway.

<input type="checkbox"/>	Index	Frequency/MHz	Max Datarate	Min Datarate
<input checked="" type="checkbox"/>	0	868.1	5-SF7BW125	0-SF12BW125
<input checked="" type="checkbox"/>	1	868.3	5-SF7BW125	0-SF12BW125
<input checked="" type="checkbox"/>	2	868.5	5-SF7BW125	0-SF12BW125
<input type="checkbox"/>	3	0	5-SF7BW125	0-SF12BW125
<input type="checkbox"/>	4	0	5-SF7BW125	0-SF12BW125
<input type="checkbox"/>	5	0	5-SF7BW125	0-SF12BW125
<input type="checkbox"/>	6	0	5-SF7BW125	0-SF12BW125
<input type="checkbox"/>	7	0	5-SF7BW125	0-SF12BW125

If frequency is one of CN470/AU915/US915, you can enter the index of the channel that you want to enable in the input box, making them separated by commas.

Examples:

- 1, 40: Enabling Channel 1 and Channel 40
- 1-40: Enabling Channel 1 to Channel 40
- 1-40, 60: Enabling Channel 1 to Channel 40 and Channel 60
- All: Enabling all channels
- Null: Indicates that all channels are disabled

Support Frequency :

Enabled Channel Index:

Channel Index	Frequency/MHz	Channel Spacing/MHz	BW/kHz
0 - 15	915.2 - 918.2	0.2	125
16 - 31	918.4 - 921.4	0.2	125
32 - 47	921.6 - 924.6	0.2	125
48 - 63	924.8 - 927.8	0.2	125
64 - 71	915.9 - 927.1	1.6	500

4.2.3 Multicast Settings (UC501 Only)

UC501 supports setting up several multicast groups to receive multicast commands from network servers and users can use this feature to control devices in bulks.

1. Set working mode as Class C.
2. Enable Multicast Group and set a unique multicast address and keys to distinguish other groups. You can also keep these settings by default.

Multicast Group 1

Multicast Address

Multicast McAppSKey

Multicast McNetSKey

Multicast Group 2

Multicast Group 3

Multicast Group 4

Parameters	Description
Multicast Address	Unique 8-digit address to distinguish different multicast groups.
Multicast McAppSKey	32-digit key. Default values: Multicast Group 1: 5572404C696E6B4C6F52613230313823 Multicast Group 2: 5572404C696E6B4C6F52613230313824 Multicast Group 3: 5572404C696E6B4C6F52613230313825 Multicast Group 4: 5572404C696E6B4C6F52613230313826
Multicast McNetSKey	32-digit key. Default values: Multicast Group 1: 5572404C696E6B4C6F52613230313823 Multicast Group 2: 5572404C696E6B4C6F52613230313824

Multicast Group 3: 5572404C696E6B4C6F52613230313825

Multicast Group 4: 5572404C696E6B4C6F52613230313826

3. Add a multicast group on the network server. Take Milesight gateway as an example, go to **Network Server > Multicast Groups**, and click **Add** to add a multicast group.



Fill in the multicast group information that is the same as device settings, and select the devices that you need to control, then click **Save**.

Group Name	Configuration
Multicast Address	11111111
Multicast Network Session Key	5572404C696E6B4C6F526132
Multicast Application Session Key	5572404C696E6B4C6F526132
Class Type	Class C ▼
Datarate	DR0 (SF12, 125kHz) ▼
Frequency	505300000 Hz
Frame-counter	0
Selected Devices	
UC500 ×	



4. Go to **Network Server > Packets**, select the multicast group and fill in the downlink command, then click **Send**. The network server will broadcast the command to devices that belong to this multicast group.

Note: ensure all devices' application ports are the same.

4.3 Interface Settings

4.3.1 Basic Settings

Parameters	Description
Reporting Interval	Reporting interval of transmitting data to network server. Default: 1200s (20 mins), Range: 10-64800 s. Note: RS232 transmission will not follow the reporting interval.
Collection Interval	The interval of collecting data when there is an alarm command (see section 4.4). This interval must be not more than reporting interval.
Data Storage	Disable or enable reporting data storage locally. (see section 4.5)
Data Retransmission	Disable or enable data retransmission. (see section 4.6)
The device returns to the power supply state	If the device loses power and return to power supply, it will be either on or off, depending on this parameter.
Change Password	Change the password for ToolBox App to read/write this device or software to login.

4.3.2 Analog Input

1. Connect analog device to analog input ports on interface 1. If the analog device requires power from the UC50x, connect the power cable of analog device to the power output on interface 1.
2. Enable analog input and configure analog settings according to the requirements of the analog sensor .

Interface 1 (Pin1) 5/9/12V Output	<input checked="" type="checkbox"/>
Power Output Time Before Collect	<input type="text" value="1"/> s
Power supply current	<input type="text" value="0.00"/> mA
Interface 1 (Pin2) 3.3V Output	<input checked="" type="checkbox"/>
Power Supply Mode	<input type="text" value="Continuous power supply"/>
Power supply current	<input type="text" value="0.00"/> mA

Interface Name	Analog Input 1	
Enable	<input checked="" type="checkbox"/>	
Analog Input Signal Type	<input type="text" value="4-20 mA"/>	
Osh	<input type="text" value="20.00"/>	
Osl	<input type="text" value="4.00"/>	
Unit	<input type="text" value="mA"/>	
Status	<input type="text" value="—"/>	<input type="button" value="Fetch"/>
Interface Name	Analog Input 2	
Enable	<input checked="" type="checkbox"/>	
Analog Input Signal Type	<input type="text" value="4-20 mA"/>	
Osh	<input type="text" value="20.00"/>	
Osl	<input type="text" value="4.00"/>	
Unit	<input type="text" value="mA"/>	
Status	<input type="text" value="—"/>	<input type="button" value="Fetch"/>

Parameters	Description
Interface 1(Pin 1) 5V/9V/12V Output	Enable 5V/9V/12V power output of interface 1 to supply power to analog devices. It's 12V by default and you can change DIP switches to change voltage.

	<p>Power Output Time Before Collect: power supply time before collecting data for terminal device initialization. Range: 0-600s.</p> <p>Power Supply Current: supply current as sensor required. Range: 0-60mA</p>
Interface 1(Pin 2) 3.3V Output	<p>Enable 3.3V power output of interface 1 to supply power to analog devices.</p> <p>Power Supply Mode: Select “Continuous power supply” or “Configurable power supply time”.</p> <p>Power Output Time Before Collect: power supply time before collecting data for terminal device initialization. Range: 0-600s.</p> <p>Power Supply Current: supply current as sensor required. Range: 0-60mA</p>
Analog Input Signal Type	4-20mA or 0-10V are optional. This only works when DIP switches has changed.
Osh/Osl	Osh is the high limit of the scale and osl is the low limit of the scale for the scaled output value. After setting, the device will upload the scaled values.
Unit	The data unit of this sensor, it just displays on ToolBox for reference.
Fetch	Click to fetch current value of sensor.

Note: analog input scaling formula

$$Ov = [(Osh - Osl) * (Iv - Isl) / (Ish - Isl)] + Osl$$

This can also be rewritten as:

$$Ov = [(Osh - Osl)/(Ish - Isl)/(Ish - Isl)] + Osl$$

The variables are pertinent to the scaling formula:

Ov = scaled output value

Iv = analog input value

Osh = high limit of the scale for the scaled output value

Osl = low limit of the scale for the scaled output value

Ish = high limit of the scale for the analog input value

Isl = low limit of the scale for the analog input value

For example, a analog wind sensor can us 4-20mA to point to 0-32 m/s, the corresponding variables are: Osh=32 m/s, osl=0 m/s, Ish=20mA, Isl=4mA.

When it measures 6mA, the real wind speed is $Ov = [(32 - 0) * (6 - 4) / (20 - 4)] + 0 = 4$ m/s.

3. For ToolBox software, click **Fetch** to check if UC50x can read correct data from analog devices.

Note: When you use power output to power analog devices, it only supplies power when reporting interval is coming. It's suggested to power slave devices with external power during the PoC test.

Interface Name	Analog Input 1
Enable	<input checked="" type="checkbox"/>
Analog Input Signal Type	4-20 mA
Osh	20.00
Osl	4.00
Unit	mA
Status	0.000 mA <input checked="" type="checkbox"/> <input type="button" value="Fetch"/>

For ToolBox App,

- Click **Collect** and attach smart phone to the device to collect data.
- Click **Fetch** and attach smart phone to the device to read the data.

Analog Input 1	<input checked="" type="checkbox"/>
Analog input Signal Type	4-20mA
Osh	20.00
Osl	4.00
* Unit	mA
Status	- <input type="button" value="Collect"/>

4.3.3 RS485

- Connect RS485 device to RS485 port on interface 2. If the RS485 device requires power from UC50x, connect the power cable of RS485 device to the power output on interface 2.
- Enable RS485 and configure serial port settings the **same** as RS485 terminal devices.

Enable	<input checked="" type="checkbox"/>
Interface Type	RS485 (Modbus Master) ▾
Interface 2 (Pin1) 5/9/12V Output	<input checked="" type="checkbox"/>
Power Output Time Before Collect	<input type="text" value="1"/> s
Power supply current	<input type="text" value="0.00"/> mA
Interface 2 (Pin2) 3.3V Output	<input type="checkbox"/>
Baud Rate	9600 ▾
Data Bit	8 bits ▾
Stop Bit	1 bits ▾
Parity	None ▾
Execution Interval	<input type="text" value="50"/> ms
Max Resp Time	<input type="text" value="500"/> ms
Max Retry Times	<input type="text" value="3"/>
Modbus RS485 bridge LoRaWAN	<input checked="" type="checkbox"/> 

Parameters	Description
Interface 2(Pin 1) 5V/9V/12V Output	<p>Enable 5V/9V/12V power output of interface 2 to supply power to RS485 terminal devices. It's 12V by default and you can change DIP switches to change voltage.</p> <p>Power Output Time Before Collect: power supply time before collecting data for terminal device initialization. Range: 0-600s.</p> <p>Power Supply Current: supply current as sensor required. Range: 0-60mA</p>
Interface 2(Pin 2) 3.3V Output	<p>Enable 3.3V power output of interface 2 to supply power to RS485 terminal devices.</p> <p>Power Supply Mode: Select "Continuous power supply" or "Configurable power supply time".</p> <p>Power Output Time Before Collect: power supply time before collecting data for terminal device initialization. Range: 0-600s.</p> <p>Power Supply Current: supply current as sensor required. Range: 0-60mA</p>
Baud Rate	1200/2400/4800/9600/19200/38400/57600/115200 are available.
Data Bit	8 bit is available.
Stop Bit	1 bit/2 bit are available.

Parity	None, Odd and Even are available.
Execution Interval	The execution interval between each Modbus command.
Max Resp Time	The maximum response time that the UC50x waits for the reply to the command. If it does not get a response after the max response time, it is determined that the command has timed out.
Max Retry Time	Set the maximum retry times after device fails to read data from RS485 terminal devices.
Modbus RS485 bridge LoRaWAN	If this mode is enabled, network server can send any type of command to RS485 device and RS485 device can only react according to server commands. Port: Select from 2-84, 86-223.

3. Click  to add Modbus channels, then save configurations.

Fetch All

Channel ID	Name	Slave ID	Address	Quantity	Type	Byte Order	Sign	Value			
1	1	1	0	1	Holding Register(INT16)	AB	<input type="checkbox"/>		<input checked="" type="checkbox"/>	Fetch	✕
2	2	255	2	1	Coil		<input checked="" type="checkbox"/>		<input checked="" type="checkbox"/>	Fetch	+ ✕

Save Up to 32 channels

Parameters	Description
Channel ID	Select the channel ID you want to configure from 16 channels.
Name	Customize the name to identify every Modbus channel.
Slave ID	Set Modbus slave ID of terminal device.
Address	The starting address for reading.
Quantity	Set read how many digits from starting address. It fixes to 1.
Type	Select data type of Modbus channels.
Byte Order	Set the Modbus data reading order if you configure the type as Input Register or Holding Register. INT32/Float: ABCD, CDBA, BADC, DCBA INT16: AB,BA
Sign	The tick indicates that the value has a plus or minus sign.
Fetch	After click, the device will send Modbus read command to test if it can read correct values. Example: as this setting, the device will send command: 01 03 00 00 00 01 84 0A

Channel Settings									
Channel ID	Name	Slave ID	Address	Quantity	Type	Byte Order	Sign	Value	
1	temperature	1	0	1	Holding Register(INT16)	AB	<input type="checkbox"/>		<input checked="" type="checkbox"/> Fetch

4. For ToolBox software, click **Fetch** to check if UC50x can read correct data from terminal devices. You can also click **Fetch** on the top of list to fetch all channel data.

Note:

- 1) When you use power output to power RS485 Modbus slave devices, it only supplies power when reporting interval is coming. It's suggested to power slave devices with external power during the PoC test.
- 2) Do not click **Fetch** frequently since response time to reply is differ for every terminal device.

4	C	1	0	1	Input Register(INT16)	AB	<input type="checkbox"/>	21	<input checked="" type="checkbox"/> Fetch
---	---	---	---	---	-----------------------	----	--------------------------	----	---

For ToolBox App,

- a. Tap every Modbus channel, click **Collect** and attach smart phone to device to collect data.
- b. Click **Fetch** and attach smart phone to read the data. You can also tap **Collect All** and **Fetch All** to fetch all channel data.

←
1

* Name

Slave ID - 1 +

Address - 0 +

Quantity 1

Type

Byte Order

Sign

Value

4.3.4 RS232

1. Connect RS232 device to RS232 port on interface 2. If the RS232 device requires power from the UC501, connect the power cable of RS232 device to the power output on interface 2.
2. Enable RS232 and configure serial port settings the **same** as RS232 terminal devices.

Enable	<input checked="" type="checkbox"/>
Interface Type	RS232
Interface 2 (Pin1) 5/9/12V Output	<input checked="" type="checkbox"/>
Interface 2 (Pin2) 3.3V continuous Output	<input type="checkbox"/>
Baud Rate	9600
Data Bit	8 bits
Stop Bit	1 bits
Parity	None
Port	86



Parameters	Description
Interface 2(Pin 1) 5V/9V/12V Output	Enable 5V/9V/12V power output of interface 2 to supply power to RS232 terminal devices continuously . It is 12V by default and you can change DIP switches to change voltage. Only UC501 supports this feature. Power Supply Current: supply current as sensor required. Range: 0-60mA
Interface 2(Pin 2) 3.3V Continuous Output	Enable 3.3V power output of interface 2 to supply power to RS232 terminal devices continuously . Power Supply Current: supply current as sensor required. Range: 0-60mA
Baud Rate	300/1200/2400/4800/9600/19200/38400/57600/115200 are available.
Data Bit	8 bit is available.
Stop Bit	1 bit/2 bit are available.
Parity	None, Odd and Even are available.
Port	The port used for RS232 data transmission.

4.3.5 GPIO

1. Connect devices to GPIO ports on interface 2.
2. Enable GPIO port and select the GPIO type as required.

Digital Input:

Digital input can be used to detect high or low status of devices.

Interface Name	GPIO 1	
Enable	<input checked="" type="checkbox"/>	
Interface Type	Digital Input1	
Digital Input		Pull Down
Status	Low	 Fetch

Parameters	Description
Digital Input	Initial status of digital input. Pull Down: rising edge will be triggered Pull Up/None: falling edge will be triggered
Fetch	Click to get current status of digital input.



Digital Output:

Digital output will send voltage signals to control devices.

Interface Name	GPIO 2	
Enable	<input checked="" type="checkbox"/>	
Interface Type	Digital Output2	
Status	Low	Fetch Switch

Parameters	Description
Fetch	Click to get current status of digital output.
Switch	Click to switch the digital output status to check if UC50x can trigger devices.

Pulse Counter:

Interface Name	GPIO 1	
Enable	<input checked="" type="checkbox"/>	
Interface Type	Counter	
Digital Input		Pull Down
Digital Filter		<input checked="" type="checkbox"/>
keep last value when power off	<input type="checkbox"/>	
Counter values	0	Refresh Start Clear
Modify the count values	<input type="text"/>	

Parameters	Description
Digital Input	Initial status of counter. Pull Down: Increase 1 when detecting rising edge Pull Up/None: Increase 1 when detecting falling edge
Digital Filter	It's recommended to enable when pulse period is greater than 250 us.
Keep last value when power off	Keep the counted values when the device powers off.
Start/Stop	Make the device start/stop counting. Note: UC50x will send non-changable counting values if you do not click Start .
Refresh	Refresh to get latest counter values.
Clear	Count the value from 0.
Modify the count values	Set the initial counting value.

4.3.6 SDI-12



1. Connect SDI-12 sensor to SDI-12 port on interface 2. If the SDI-12 device requires power from the UC50x, connect the power cable of SDI-12 device to power output on interface 2.
2. For ToolBox software, enable SDI-12 interface and configure interface settings to be the **same** as those of the SDI-12 sensors. For ToolBox App, go to **Device > Setting > SDI-12 Settings** and click **Read** to get current settings, then configure the settings.

Enable	<input checked="" type="checkbox"/>
Interface 2 (Pin1)5/9/12V Output	<input checked="" type="checkbox"/>
Power Output Time Before Collect	<input type="text" value="1"/> s
Power supply current	<input type="text" value="10.00"/> mA
Baud Rate	<input type="text" value="1200"/>
Data Bit	<input type="text" value="7 bits"/>
Stop Bit	<input type="text" value="1 bits"/>
Parity	<input type="text" value="Even"/>
Max Retry Times	<input type="text" value="3"/>
SDI-12 bridge LoRaWAN	<input checked="" type="checkbox"/>
Port	<input type="text" value="80"/>

Parameters	Description
Interface 2(Pin 1)	Enable 5V/9V/12V power output of interface 2 to supply power to SDI-12

5V/9V/12V Output	sensors. It's 12V by default and you can change DIP switches to change voltage. Power Output Time Before Collect: power supply time before collecting data for terminal device initialization. Range: 0-600s. Power Supply Current: supply current as sensor required. Range: 0-60mA
Baud Rate	1200/2400/4800/9600/19200/38400/57600/115200 are available.
Data Bit	8 bit/7 bit is available.
Stop Bit	1 bit/2 bit is available.
Parity	None, Odd and Even are available.
Max Retry Time	Set the maximum retry times after device fails to read data from SDI-12 sensors.
SDI-12 bridge LoRaWAN	If this mode is enabled, network server can send SDI-12 command to SDI-12 device and the device can only react according to server commands. Port: Select from 2-84, 86-223.

Note: When you use power output to power SDI-12 sensors, it only supplies power when reporting interval is coming. It's suggested to power sensors with external power during the PoC test.

- Click  to add channels, click **Read** to get the address of this sensor.
- Click  besides the **SDI-12 Command** tab to add SDI-12 commands as required by the sensor.
- Click **Collect** to send the commands to get sensor data, then click **Fetch** to check the data.



Parameters	Description
Channel ID	Select the channel ID you want to configure from 16 channels.
Name	Customize the name of each channel to easily identify them
Address	Address of SDI-12 sensor, it is editable.
Read	Click to read the address of the SDI-12 sensor.
Write	Modify the Address and click to write a new address to SDI-12 sensor.
SDI-12 Command	Fill in the commands to send to sensors, one channel can add 16 commands at most.
Collect	Click to send commands to get sensor data.

	Note: Do not click frequently since response time to reply is differ for every terminal device.
Fetch	Click to display the data on the ToolBox.
Value	Show the collected value. If it read multiple values, it will be separated by "+" or "-".

For ToolBox App,

- Tap every channel, click **Collect** and attach smart phone to the device to collect data.
- Click **Fetch** and attach smart phone to the device to read the data. You can also tap **Collect All** and **Fetch All** to fetch all channel data.

The screenshot shows the 'Edit channel' screen in the ToolBox App. At the top, there is a blue header with a back arrow and the text 'Edit channel'. Below this, the 'Channel' is set to 'Channel 1'. The 'Name' field contains '1'. The 'Address' field contains 'A', with 'Read' and 'Write' buttons above it. The 'SDI-12 Command' section has two input fields: the first contains 'aM!' and the second contains 'aD0!'. There are '+' and '-' icons next to the second command field. At the bottom, the 'Value' field displays 'A+0.0+0+26.0' and a 'Collect' button is visible.

4.4 Alarm Settings

UC50x supports configuring commands to send alarm packets to network server. Each device can be added 16 threshold alarm commands at most.

- For ToolBox software, go to **Command** page, click **Edit** to add commands; for ToolBox App, go to **Device > Setting > Rule Engine** to add commands.

ID	Configuration	Edit
1		
2		

2. Set an IF condition including the analog input values or RS485 Modbus channel values. When the value matches the condition, the device will report an alarm packet.

Note: the device will only send the alarm once. Only when the value turns back to normal and triggers the condition again, it will send a new alarm.

Configuration for command NO.1

If

mA

Above
 Below
 Within
 Change

Then

3. After setting all commands, click **Save**.

ID	Configuration	Edit	Delete
1	If ai2(4-20ma) is above 5.00. then report data package		
2	If ai1(4-20ma) is within 4.00 - 6.00. then report data package		
3			

4.5 Data Storage

UC50x series supports storing 600 data records locally and exports data via ToolBox App or ToolBox software. The device will record the data according to the reporting interval even if it is not connected to a network.

1. Go to **Status** of ToolBox software or **Device > Status** of ToolBox App to sync the device time;



2. Go to **General > Basic** of ToolBox software or **Device > Settings > General Settings** of ToolBox App to enable data storage feature.

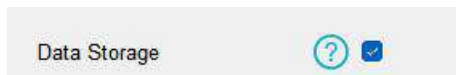

3. Go to **Maintenance > Backup and Reset** of ToolBox software or **Device > Maintenance** of ToolBox App, click **Export**, then select the data time range and click **Save** to export data.

Note: ToolBox App can only export the last 14 days' data. If you need to export more data, please use ToolBox software.

Maintenance >

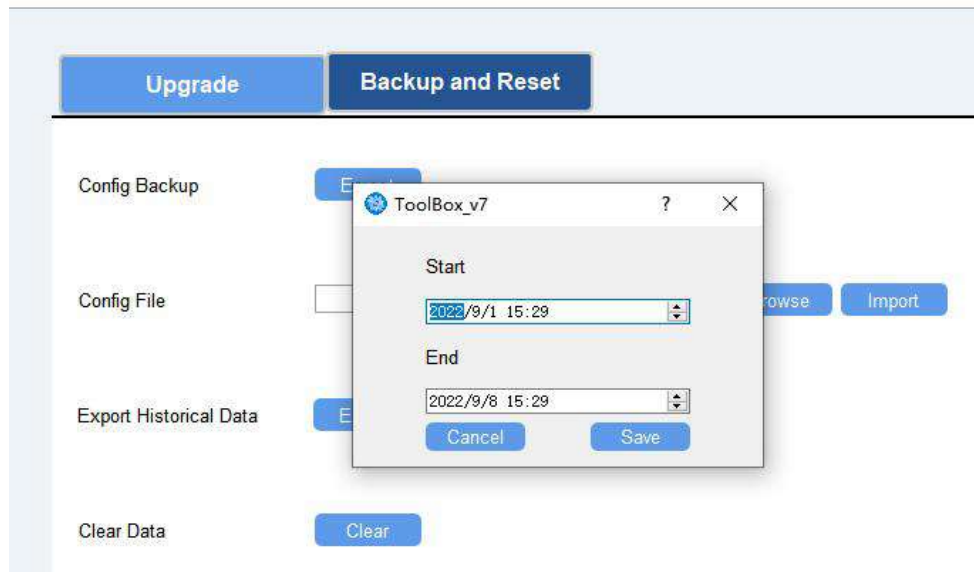

4. Click **Clear** to clear all stored data inside the device if necessary.

4.6 Data Retransmission

UC50x series supports data retransmission to ensure the network server can get all data even if the network is down for some times. There are two ways to get the lost data:

- Network server sends downlink commands to enquire the historical data for specified time range, see ***UC50x Series Communication Protocol***;
- When network is down if no response from LinkCheckReq MAC packets for a period of time, the device will record the network disconnected time and re-transmit the lost data after the device re-connects the network.

Here are the steps for data retransmission:

1. Enable data storage feature and data retransmission feature;

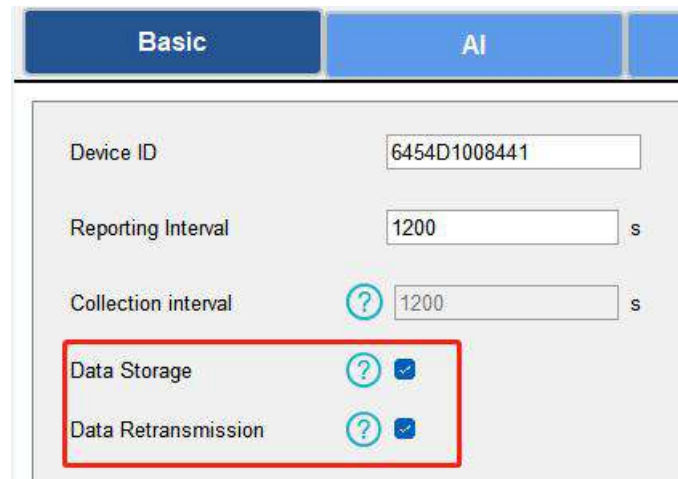

2. Enable rejoin mode feature and set the number of packets sent. Take below as an example, the device will send LinkCheckReq MAC packets to the network server regularly to check if the network is disconnected; if there is no response for 8+1 times, the join status will change to de-active and the device will record a data lost time point(the time to join the network).



3. After the network connected back, the device will send the missing data, starting from the point in time when the data was lost, according to the reporting interval.

Note:

- 1) If the device is rebooted or powered off during data retransmission and the process is not completed, the device will resend all retransmitted data again after reconnecting to the network;
- 2) If the network is disconnected again during data retransmission, it will only send the latest disconnection data;
- 3) The retransmission data format is started with "20", please refer to ***UC50x Series Communication Protocol***.
- 4) Data retransmission will increase the uplinks and shorten the battery life.

4.7 Maintenance

4.7.1 Upgrade

ToolBox Software:

1. Download firmware from Milesight official website to your PC.
2. Go to **Maintenance > Upgrade** of ToolBox software, click **Browse** to import firmware and upgrade the device.

Note: Any operation on ToolBox is not allowed during upgrading, otherwise the upgrading will be interrupted, or even the device will break down.

Upgrade	Backup and Reset
Model:	UC501-470M
Firmware Version:	01.03
Hardware Version:	3.0
Domain:	Beijing Server
FOTA:	Up to date
Local Upgrade	<input type="text"/> <input type="button" value="Browse"/> <input type="button" value="Upgrade"/>

ToolBox App:

1. Download firmware from Milesight official website to your smart phone.
2. Open ToolBox App and click **Browse** to import firmware and upgrade the device.

Note:

- 1) Operation on ToolBox is not supported during the upgrade.
- 2) Only Android version ToolBox supports the upgrade feature.

Status	Setting	Maintenance
SN		6412B3029235
Model		UC501-868M
Firmware Version		V1.2
Hardware Version		V2.0
Manual Upgrade		
<input type="button" value="Browse"/>		

4.7.2 Backup

UC50x devices support configuration backup for easy and quick device configuration in bulk. Backup is allowed only for devices with the same model and LoRaWAN® frequency band. Please select one of following methods to backup device:

ToolBox Software:

1. Go to **Maintenance > Backup and Reset**, click **Export** to save current configuration as json format backup file.
2. Click **Browse** to select backup file, then click **Import** to import the configurations.

The screenshot shows the 'Backup and Reset' section of the ToolBox Software interface. It features three main rows of controls:

- Config Backup:** A blue button labeled 'Export' is positioned to the right of the 'Config Backup' label.
- Config File:** A text input field is followed by two blue buttons: 'Browse' and 'Import'.
- Restore Factory Defaults:** A blue button labeled 'Reset' is positioned to the right of the 'Restore Factory Defaults' label.

ToolBox App:

1. Go to **Template** page on the App and save current settings as a template. You can also edit the template file.
2. Select one template file which saved in the smart phone and click **Write**, then attach to another device to write configuration.

The screenshot shows the 'Template' page in the ToolBox App. A 'New Template' dialog box is displayed in the center, prompting the user to enter a template name. The dialog contains the following elements:

- Title:** 'New Template'
- Text:** 'Please enter template name'
- Input Field:** Contains the text 'UC500-915M_20201228'.
- Buttons:** 'Cancel' and 'OK'.

Below the dialog, a blue button labeled 'Save as a New Template' is visible. The background shows a list of templates, with the selected one being 'EM500-UDL-868M_20201124' (Last Modified Time: 2020-11-24 17:05:20). The bottom navigation bar shows 'Device' and 'Template' icons.

4.7.3 Reset to Factory Default

Please select one of following methods to reset device:

Via Hardware: Open the case of UC50x and hold on power button more than 10s.

Via ToolBox Software: Go to **Maintenance > Backup and Reset** to click **Reset**.



Via ToolBox App: Go to **Device > Maintenance** to click **Reset**, then attach smart phone with NFC area to UC50x to complete reset.

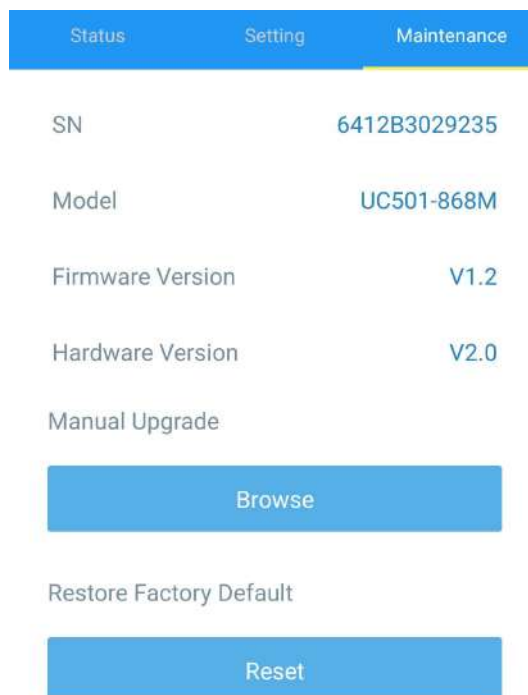

5. Installation

UC50x series support wall mounting or pole mounting. Before installation, make sure you have the mounting bracket, wall or pole mounting kits and other required tools.

Wall Mounting:

1. Fix the wall plugs into the wall, then fix the mounting bracket to the wall plugs with screws.

- Put the device on the mounting bracket, then fix the bottom of the device to the bracket with a fixing screw. It's necessary to fix this bracket to device, or it will affect the signal.

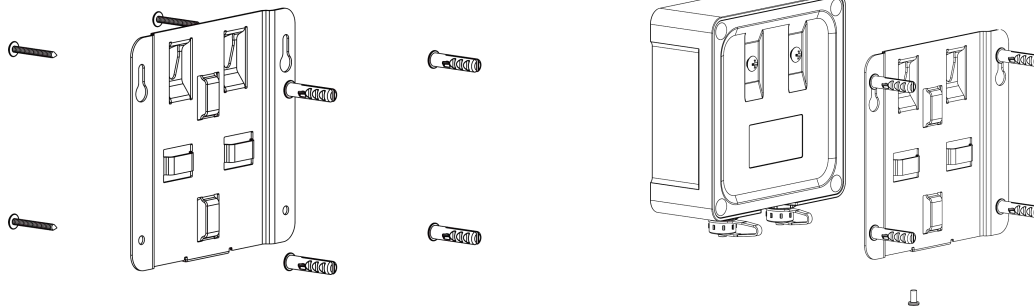

Pole Mounting:

- Straighten out the hose clamp and slide it through the rectangular rings in the mounting bracket, wrap the hose clamp around the pole. After that use a screwdriver to tighten the locking mechanism by turning it clockwise.
- Put the device on the mounting bracket, then fix the bottom of the device to the bracket with a fixing screw. It's necessary to fix this bracket to device, or it will affect the signal.



6. Milesight IoT Cloud Management

UC50x series can be managed by Milesight IoT Cloud platform. Milesight IoT cloud is a comprehensive platform that provides multiple services including device remote management and data visualization with the easiest operation procedures. Please register a Milesight IoT Cloud account before operating following steps.

- Ensure Milesight LoRaWAN[®] gateway is online in Milesight IoT Cloud. For more info about connecting gateway to cloud please refer to gateway's user guide.



2. Go to **My Devices** page and click **+New Devices**. Fill in the SN of UC50x and select associated gateway.

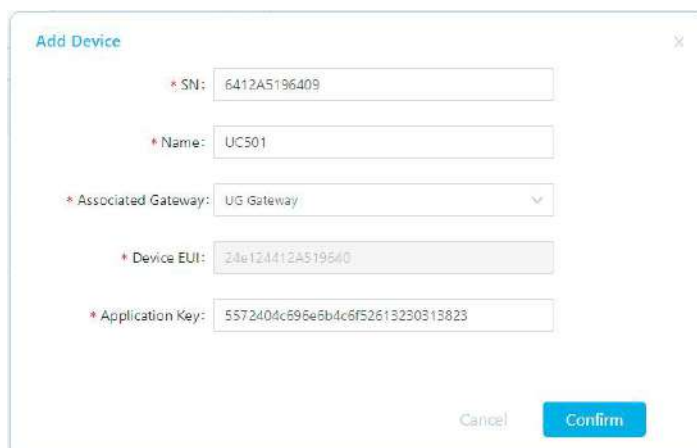

Add Device

* SN: 6412A5196409

* Name: UC501

* Associated Gateway: UG Gateway

* Device EUI: 24e124412A519640

* Application Key: 5572404c696e6b4c6f52613230313823

Cancel Confirm

3. For UC501, click  and go to **Basic Settings** to change class type the same as device settings.

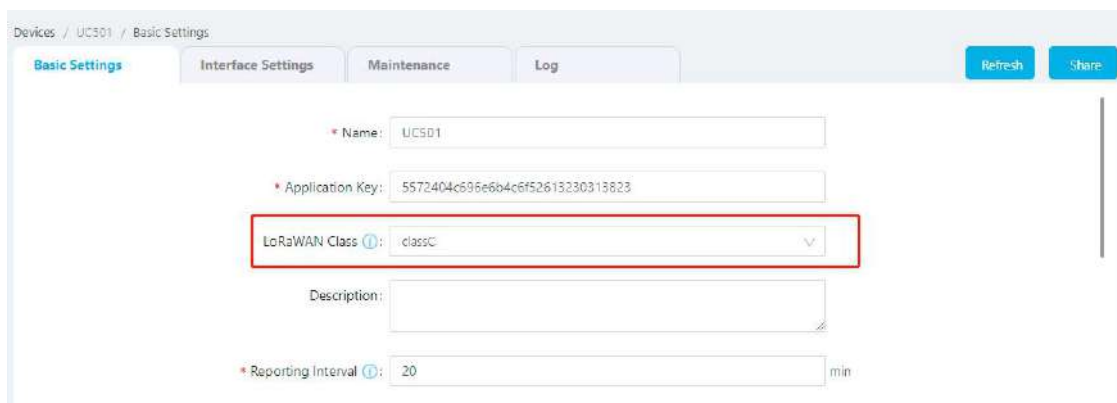

Devices / UC501 / Basic Settings

Basic Settings Interface Settings Maintenance Log Refresh Share

* Name: UC501

* Application Key: 5572404c696e6b4c6f52613230313823

LoRaWAN Class: classC

Description:

* Reporting Interval: 20 min

4. After UC50x is online in Milesight IoT Cloud, click  and go to **Interface Settings** to select used interfaces and customize the name, sign and formulas.

Note: Modbus channel settings should be the same as the configuration in ToolBox.

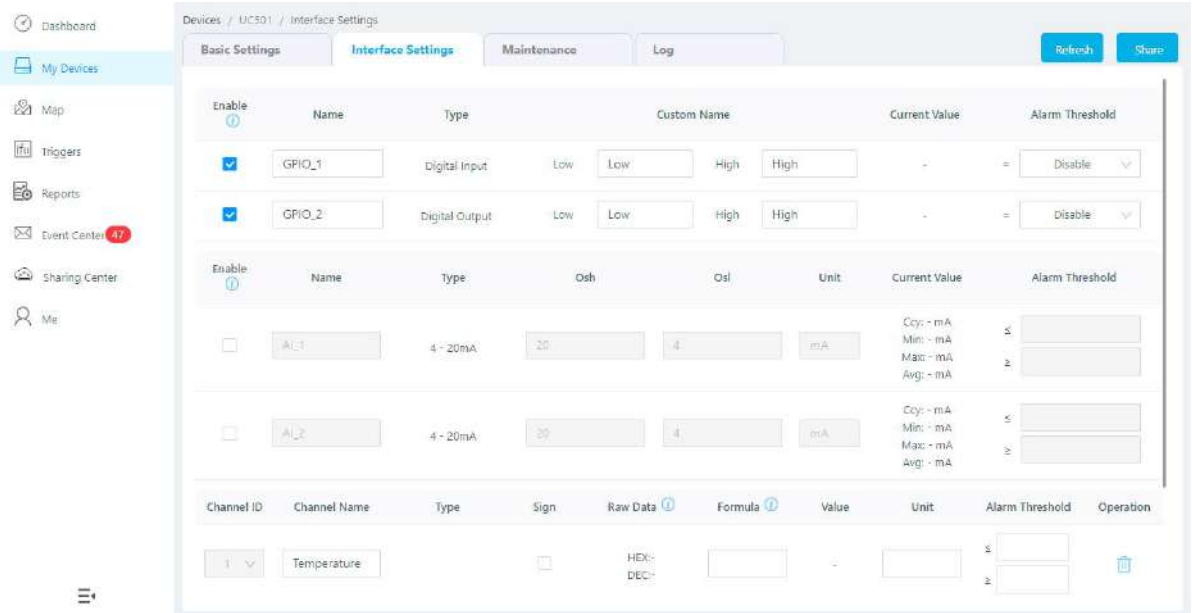

7. Device Payload

UC50x Series use the standard Milesight IoT payload format based on IPSO. Please refer to the ***UC50x Series Communication Protocol***, for decoders of Milesight IoT products please click [here](#).

-END-